

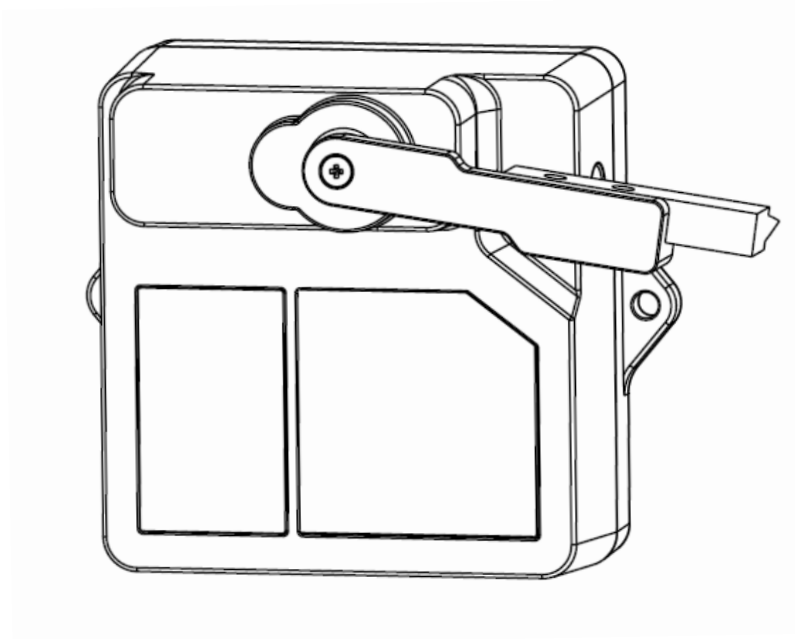

TF02-Pro-W User Manual



PREFACE

Dear users:

Thank you for choosing Benewake products. In the purpose of offering better operation experience to you, we hereby write this manual for an easier and simpler operation of our product, hoping to better solve the common problems you may meet.

This user manual contains the relevant information on product introduction, usage and maintenance of TF02-Pro-W, covers the product operation introduction and common problem solutions. Please read this manual carefully before using the product. Remember the precautions to avoid hazards, and please follow the described steps in the manual when using it.

If you have any problems in the process of usage, you are welcome to contact Benewake at any time for help.

Contact details

Official website: en.benewake.com

TEL : +86-10- 57456983

Technical questions, please contact : support@benewake.com

Consult sale information or request brochure, please contact : bw@benewake.com

Headquarters Address

Benewake (Beijing) Co., Ltd.

No.3030, 3rd Floor, Independent Innovation Building, No.6 Chuangye Road, Haidian District, Beijing, China

Copyright Statement

This User Manual is copyright © of Benewake. Please do not modify, delete or translate the description of this manual contents without the official written permission from Benewake.

Disclaimer

As our products are constantly improving and updating, the specifications of TF02-Pro-W are subject to change. Please refer to the official website for latest version.

CONTENTS

1	OVERVIEW.....	1
1.1	Technical Specification.....	1
1.2	Maintenance and Cleaning.....	2
1.3	Appearance and Structure	2
1.4	Storage	4
2	INTERFACE.....	5
2.1	Description About Wiring Sequence	5
2.2	Electrical Characteristics.....	5
3	COMMUNICATION PROTOCOL	6
3.1	Serial Communication Protocol	6
3.2	Serial Communication Data Format	6
3.2.1	Standard data output format	6
3.2.2	Character string data format.....	7
3.3	I ² C Communication Protocol.....	7
3.4	Timing Sequence Description of I ² C	7
4	PARAMETER CONFIGURATION.....	8
4.1	Command Convention.....	8
4.2	Configuration Commands.....	8
4.2.1	General parameters configuration.....	8
4.2.2	Wiper working and configuration	10
5	QUICK TEST GUIDE	13
5.1	Tools Required for Test.....	13
5.2	Test Procedures.....	13
6	Firmware Update	15
7	Q&A	17
	Attachment-1 BW_TFDS software.....	18

1 OVERVIEW

TF02-Pro-W is a single-point ranging LiDAR specially developed for level detection, based on the ToF (Time of Flight) principle and provides stable, accurate and reliable ranging performance by optimizing the optical system and utilizing built-in algorithms, operating range up to 25m. TF02-Pro-W is equipped with a unique dust-removal wiper, which automatically cleans the lens of front panel of LiDAR regularly to solve the soiling problems, and can maintain the accuracy of ranging detection in heavy dust environment, open configuration interface for user-defined dust removal configuration.

1.1 Technical Specification

Table 1-1 Technical Specification of TF02-Pro-W-

Type	Parameters	Value	
Product performance	Operating range	90% reflectivity, 0Klux	0.1~25m
		10% reflectivity, 0Klux	0.1~12m
		90% reflectivity, 100Klux	0.1~25m
		10% reflectivity, 100Klux	0.1~12m
	Accuracy ^①	±6cm (0.1m~6m), ±1% (6m~25m)	
	Distance resolution ^①	1cm	
	Frame rate ^②	1Hz~1000Hz (adjustable, default 100Hz)	
	Repeatability ^①	1σ: <2cm (0.1m~25m@90% reflectivity)	
	Ambient light immunity	100Klux	
	Enclosure rating	IP5X	
Optical parameters	Photobiological safety	Class1 (IEC60825)	
	Central wavelength	850nm	
	Light source	VCSEL	
	FoV ^③	3°	
Electrical parameters	Supply voltage	DC 5V	
	Average current	≤400mA	
	Power consumption	≤2W	
	Peak current	1A	
Others	Dimension	85mm×59mm×43mm (L×H×W)	
	Housing	PC/ABS	

	Operating temperature	-20°C~60°C
	Storage temperature	-30°C~80°C
	Weight	90g (with cables)
	Cable length	120cm

**Note**

- ① The detection is measured with the standard white board (90% reflectivity).
- ② The frame rate can be adjusted. The default value is 100Hz and the maximum value is 1000Hz, the customized frame rate should be calculated by the formula: $2000/n$ (n is an integer with ≥ 2).
- ③ The angle is a theoretical value, the actual angle value has some deviation.

1.2 Maintenance and Cleaning

- Before switching on, please check if the exposed window mirror is clean, and clean it promptly if it is dirty.
- After using the device, check the optics. If it is contaminated, please clean it promptly.
- The optics should be cleaned regularly if the device be operated in a severe environment for a long time.
- Before regular cleaning, please disconnect the power. Using a soft cloth to gently wipe the window in the same direction when the device is not operating, to avoid repeated wiping and damage to the window mirror.
- Do not remove the dust-removal wiper, which may cause equipment failure. If the dust-removal wiper is abnormal, please contact bw@benewake.com.
- When the steering shaft is blocked by dust for a long time, the steering shaft may be damaged due to the increased resistance. Please clean the steering shaft regularly.
- If you require deep cleaning of internal optics, please contact bw@benewake.com to offer professional advice.

1.3 Appearance and Structure

The appearance and dimensions of TF02-Pro-W are shown in Figure 1-1 and Figure 1-2.



Figure 1-1 Appearance of TF02-Pro-W-

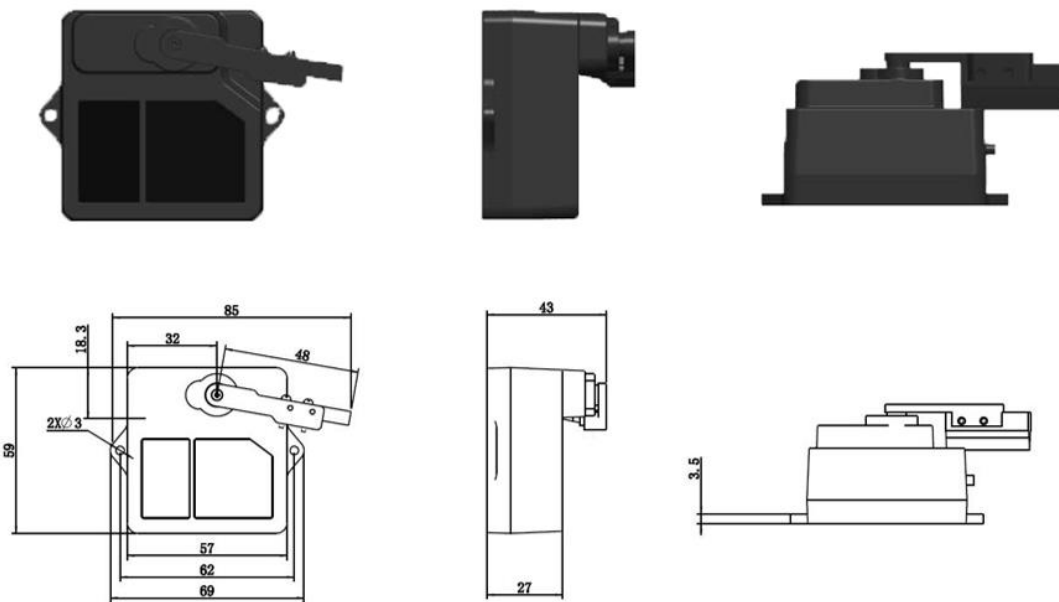

Figure 1-2 Dimension of TF02-Pro-W (Unit: mm)

TF02-Pro-W is recommended to use M2.5 round Phillips screws for installation. Please remove the protective film of the optical lens before use. The lens of front panel of LiDAR cannot be covered. Please keep it clean. The surface of optical lens is the ranging zero of LiDAR.

The detection angle of TF02-Pro-W is 3°. At different distances, the size of light spot, namely the edge length of the detection range, is different, as shown in Figure 1-3. Side length of the detection range at different distances (the detection range is a square), as shown in Table 1-2.



Note

The side length of target object generally should be larger than size of the TF02-Pro-W light spot; if the side length of the detected object is smaller than size of light spot, the output (Distance) from TF02-Pro-W will be a value between the actual distance values of the two objects.

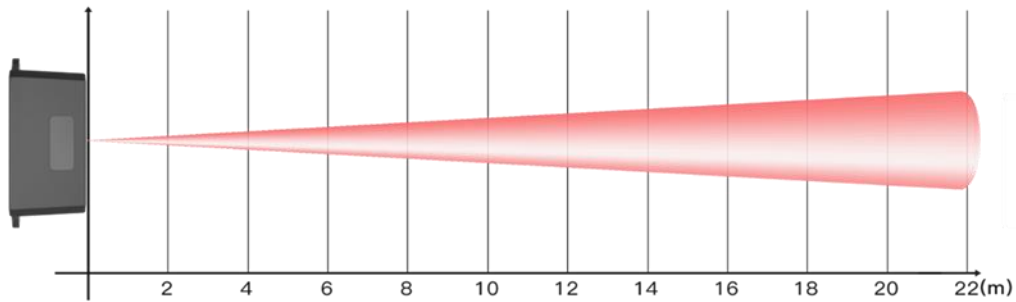

Figure 1-3 The spot size at different distances

Table 1-2 Spot Size at Different Distances

Distance (m)	1	2	3	4	5	6	7	8	9	10	15	20	22
Spot Size (cm)	5	10	16	21	26	31	37	42	47	52	79	105	115

1.4 Storage

- Device should be stored at -30°C to 80°C with a relative humidity $\leq 60\%$ and ventilation free from corrosive gases.
- Before storage, please make sure that all connections are disconnected or dust covers are inserted or covered to ensure cleanliness.
- If storage time is over three months, please carry out a working test before using, to ensure that the device can be used in normal condition.
- For ensuring the product performance, do not open the product shell or remove the IR-pass filter.

2 INTERFACE

2.1 Description About Wiring Sequence

The external tail cable of TF02-Pro-W has no connector by default, the wiring sequence is shown in Table 2-1.

Table 2-1 The Function Description of Each Wire

Cable Color	Function	Comment
Red	VCC	Power supply
Black	GND	Ground
White	RXD/SDA	Receiving/Data
Green	TXD/SCL	Transmitting/Clock

2.2 Electrical Characteristics

TF02-Pro-W has no overvoltage and reverse polarity protection, so please make sure that connection and power supply are normal. The electrical characteristics are shown in Table 2-2.

Table 2-2 Main Electrical Parameters of TF02-Pro-W

Parameter	Value
Supply Voltage	DC 4.8V~5.5V
Average Current	$\leq 400\text{mA}$
Peak Current	1A
Average Power Consumption	$\leq 2\text{W}$
Communication Level	LVTTTL (0~3.3V)

3 COMMUNICATION PROTOCOL

3.1 Serial Communication Protocol

TF02-Pro-W adopts the serial port data communication protocol, as given in Table 3-1.

Table 3-1 Data Communication Protocol

Communication interface	UART
Default baud rate	115200
Data bit	8
Stop bit	1
Parity check	None

3.2 Serial Communication Data Format

TF02-Pro-W is available with two formats of data output, namely, the standard data output format and the character string data format, both of which are switchable with command.

3.2.1 Standard data output format

The serial data format of TF02-Pro-W is shown in Table 3-2, the data is hexadecimal, each data frame contains 9 bytes, including the distance value, signal strength, temperature of chip and data check byte (Checksum).

Table 3-2 Data Format and Code Explanation

Byte0-1	Byte2	Byte3	Byte4	Byte5	Byte6	Byte7	Byte8
0x59 59	Dist_L	Dist_H	Strength_L	Strength_H	Temp_L	Temp_H	Checksum
数据编码说明							
Byte0	0x59, frame header, same for each frame						
Byte1	0x59, frame header, same for each frame						
Byte2	Dist_L distance value low 8 bits						
Byte3	Dist_H distance value high 8 bits						
Byte4	Strength_L low 8 bits						
Byte5	Strength_H high 8 bits						
Byte6	Temp low 8 bits						
Byte7	Temp high 8 bits						
Byte8	Checksum is the lower 8 bits of the cumulative sum of number of first 8 bytes						

- Dist(Distance): The detection distance value with TF02-Pro-W, default unit is cm.

- Strength: The signal strength, the default output is between 0 and 65535. When the distance measuring gear is certain, the farther the distance is measured, the lower the signal intensity; the lower the reflectivity of the target, the lower the signal intensity
- Temp(Temperature): The chip temperature, temperature(°C) = Temp / 8 -256.

3.2.2 Character string data format

The data output is in the format of character string and its unit is m(meter). For example, if the measurement distance is 1.21m, the string 1.21 will be output, followed by the escape character `\r\n`.

3.3 I²C Communication Protocol

TF02-Pro-W supports I²C data communication interface, as shown in the table below:

Table 3-3 TF02-Pro-W I²C Data Communication Protocol

Communication Interface	I ² C
Max transmission rate	400kbps
Master/Slave mode	Slave mode
Default Address	0x10
Address range	0x01~0x7F

3.4 Timing Sequence Description of I²C

Different from the serial mode, the I²C communication is initiated by the master. TF02-Pro-W can only send and receive data passively, as slave. After sending the command from master to slave, one needs to wait for a period for the command to be processed. Then read response of LiDAR, the suggested waiting period is 100ms. Data is detailed in Table 3-4.

Table 3-4 Timing Sequence of I²C

Write operation	Start	Addr	W	A	Byte0	A	---	ByteN	A	Stop
	Wait 100ms									
Read operation	Start	Addr	R	A	Byte0	A	---	ByteN	A	Stop

4 PARAMETER CONFIGURATION

In order to allow TF02-Pro-W to solve your problems more flexibly, the function of user-defined configuration of product parameters is opened. Users can modify the original parameters of the product by sending relevant instructions, such as output data format, frame rate, dust wiper parameters, etc.

Please modify product configuration depending upon your actual demands. Do not frequently try irrelevant commands to prevent incorrect sending of command which may cause unnecessary loss. Please make sure to make the configuration as the commands listed herein. Do not send unstated command.

4.1 Command Convention

For the configuration instructions in this document, see the following command convention:

- Multi-bytes data or command frame is transmitted in little endian format. For example: set the frame rate to 1000Hz, as shown in Table 4-1. Decimal number 1000 can be converted to 0x03E8 in hexadecimal. Then it will be saved in the data or command frame as:

0x5A 0x06 0x03 0xE8 0x03 0x4E

- Command: data instruction frame sent from PC to LiDAR.
- Response: data frame sent by LiDAR to host computer or other terminals.

Before setting the relevant parameters of TF02-Pro-W, user needs to establish the connection between TF02-Pro-W and PC at first. User can send the relevant configuration-related instructions to the product via TF02-Pro-W PC software or other serial port debugging software. All commands are compatible with both UART mode and I²C mode.

4.2 Configuration Commands

4.2.1 General parameters configuration

The general parameters configuration command is shown in Table 4-1. After parameters configuration, send saving settings command to save the configuration, otherwise the settings will not take effect.

Table 4-1 General Parameter Configuration and Description of TF02-Pro-W

Parameters	Command	Response	Remark
Firmware version	5A 04 01 5F	5A 07 01 V1 V2 V3 SU ^①	Version V3.V2.V1
System reset ^②	5A 04 02 60	5A 05 02 00 60	Succeeded
		5A 05 02 01 61	Failed
Frame rate ^③	5A 06 03 LL HH SU	5A 06 03 LL HH SU	1-1000Hz, default 100Hz
Trigger detection	5A 04 04 62	Date frame	After setting the frame rate to 0, detection can be triggered with this command
Output format	5A 05 05 01 65	5A 05 05 01 65	Standard 9 bytes(cm)
	5A 05 05 02 66	5A 05 05 02 66	Character string(m)
	5A 05 05 06 6A	5A 05 05 06 6A	Standard 9 bytes (mm)
Baud rate ^④	5A 08 06 H1 H2 H3 H4 SU	5A 08 06 H1 H2 H3 H4 SU	Default 115200; E.g. 256000(DEC)=3E800(HEX) , H1=00,H2=E8,H3=03,H4=00
Enable/Disable output	5A 05 07 00 66	5A 05 07 00 66	Disable data output
	5A 05 07 01 67	5A 05 07 01 67	Enable data output
Communication interface setup	5A 05 0A MODE SU	/	00 (UART), default; 01 (I ² C)
Modify I ² C_slave_addr	5A 05 0B ADDR SU	5A 05 0B ADDR SU	Modify I ² C_slave_addr, default 0x10
Obtain data frame	5A 05 00 01 60	Data Frame (9bytes-cm)	Only works in I ² C mode
	5A 05 00 06 65	Data Frame (9bytes-mm)	
Strength threshold and distance under threshold	5A 07 22 XX LL HH SU	5A 07 22 XX LL HH SU	Strength Threshold=60, Distance under threshold=4500. E.g. When strength is below 60, make distance output 4500cm. XX=60/10=6(DEC)=06(HEX) 4500(DEC)=1194(HEX) LL=94, HH=11
Low power consumption mode	5A 06 35 0X 00 SU	5A 06 35 0X 00 SU	Range of X(HEX) is 0~A: X > 0, enable low power consumption mode; X=0, disable low power consumption mode, default
Restore to factory settings	5A 04 10 6E	5A 05 10 00 6F	Succeeded
		5A 05 10 01 70	Failed
Save settings ^⑤	5A 04 11 6F	5A 05 11 00 70	Succeeded

		5A 05 11 01 71	Failed
--	--	----------------	--------



Warning

- ① SU is checksum, checksum is disable by default.
- ② Please keep power on and wait 1s after sending system reset command, otherwise the settings will not take effect.
- ③ The customized frame rate should be calculated by the formula: $2000/n$ (n is an integer with ≥ 2).
- ④ The following baud rates are supported: 9600, 14400, 19200, 38400, 56000, 57600, 115200, 128000, 230400, 256000, 460800, 512000, 750000, 921600. When setting a high update rate, high baud rate is recommended to ensure data security. After sending baud rate command, keep power on and switch to the target baud rate before sending save setting command, it will be effective in this way.
- ⑤ After parameters configuration, send saving settings command to save the configuration, otherwise the settings will not take effect.

4.2.2 Wiper working and configuration

4.2.2.1 Wiper working

The dust-removal wiper works in a fixed period, which is customer default working mode. For every 24 hours, there will be a total of six dust-removal operations, each dust-removal operation is driven by the LiDAR servo, the wiper swings back and forth for one time. And TF02-Pro-W will also perform dust-removal operation once after each power-on. In addition, customer can control the LiDAR immediately by sending command for dust-removal, and modify the wiper swing times and save the settings. During the dust removal operation, the LiDAR does not measure and output data.

The wiper stops at position A when it does not work, and moves from position A to position B during operation, then returns to position A, the initial and termination positions are shown in Figure 4-1.

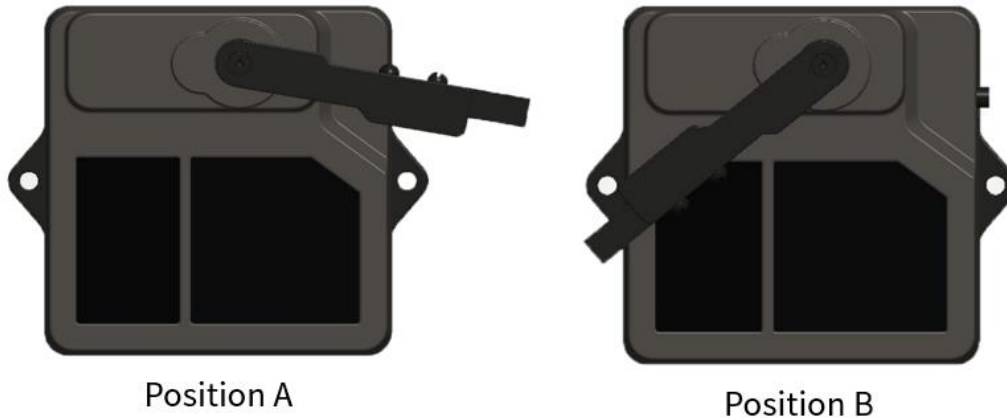

Figure 4-1 The initial and termination positions of the wiper movement

4.2.2.2 Parameters configuration of wiper

Configure the wiper parameters in the following three steps:

- 1) Enter into configuration mode:

Command: AA 55 F0 00 01 00 00 02.

Response: AA 55 F0 00 01 00 00 02, which means successful transmission.

- 2) Configuration of product parameters:

Configuration command is shown in Table 4-2.

- 3) Exit configuration mode:

Command: AA 55 F0 00 00 00 00 02.

Response: AA 55 F0 00 00 00 00 02, which means successful transmission.

For wiper dust-removal working, customer can customize the dust-removal cycle, wiper round trip times, or immediately start the wiper, the commands are shown in Table 4-2. Do not send instructions not declared in the user manual.

Table 4-2 Wiper Parameter Configuration and Description of TF02-Pro-W

Number	Parameters	Command	Remark
①	Start the wiper	AA 55 F0 00 00 00 00 B0	Use this command to start the wiper at any time during the default mode
②	Modify dust removal cycle	AA 55 F0 00 EE FF 00 B2	EE: dust removal cycle (Unit: min) high 8 bits, FF: dust removal cycle low 8 bits Note: Cycle can't be less than 1min
③	Modify the number of wiper round trips	AA 55 F0 00 EE 00 00 B3	EE: The number of round trips of the wiper during a dust removal cycle Note: No more than 10 round trips per cycle





**Warning**

- ① The wiper configuration has to be performed in a strict sequence.
 - ② If the parameter of dust removal cycle is wrong, feedback will be “AA 55 F0 03 EE FF 00 B2”. It is suggested that the dust removal interval should be more than 30 minutes under the condition of high temperature (ambient temperature > 40°C).
 - ③ If the number of wiper round trips is wrong, feedback will be “AA 55 F0 03 EE 00 00 B3”. No more than 10 round trips per cycle.
-

5 QUICK TEST GUIDE

5.1 Tools Required for Test

Table 5-1 The required tools for product test

				
TF02-Pro-W	TTL-USB Converter	USB Cable	PC	BW_TFDS Software

5.2 Test Procedures

1) Download the test software

Download the latest version BW_TFDS from <http://en.benewake.com/support>.

The introduction of BW_TFDS software is shown in Attachment-1 BW_TFDS software.

2) Connection of the hardware

Connect “TF02-Pro-W”, “TTL - USB board” and “USB cable”. Make sure there is no loose connection. Then connect “USB cable” with “PC”. As shown in Figure 5-1.

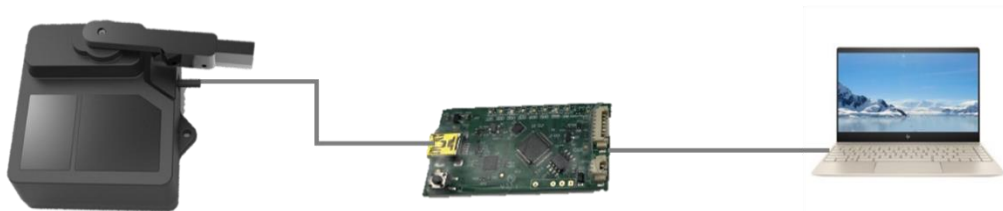

Figure 5-1 Connection of TF02-Pro-W and PC

3) Connection to the software

Run the BW_TFDS software, select “① TF02-Pro” and select automatically recognized communication port (here it is “② COM9”), choose the right baud rate (here it is “③ 115200”), as shown in Figure 5-2.

4) Data output

Then click “CONNECT”. Upon successful connection, the continuous images of the output data will be displayed in area “④ TIME LINE CHART”. Besides, the real-time data of the

current measure distance (Dist), effective data points per second (Effective Points) and signal strength (Strength) will be displayed in area “⑤ REAL TIME DATA”.

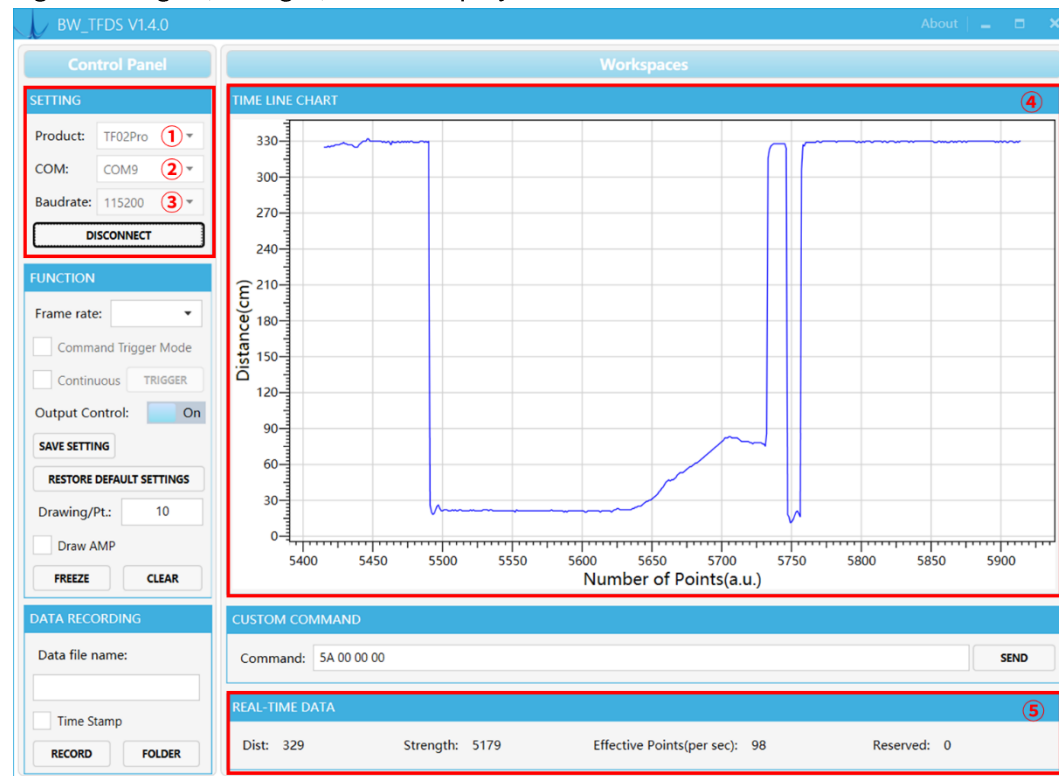

Figure 5-2 BW_TFDS software interface and display



Note

- ① Please shut down any anti-virus software before uncompressing the PC software. Otherwise, maybe the software is deleted as virus. The software is only runnable under Windows.
- ② If no data is available in area “④TIME LINE CHART”, please check the line connection and line sequence. When TF02-Pro-W is successfully powered on, there will be a red indicator light inside transmitting lens viewing from the front.
- ③ The value of distance output Dist may vary with the output unit, which is cm by default. If the unit of distance is changed to the unit-mm with specific command, and the PC software will be unable to identify it, and so the unit of “④TIME LINE CHART” will still be cm. For example, the actual TF02-Pro-W measurement is 1m, the distance value of TF02-Pro-W is 1000 in mm, the value read by the PC software also is 1000, but the unit will not change and still display cm.

6 Firmware Update

TF02-Pro-W supports the firmware upgrade. When the user's product cannot satisfy the current application requirements and Benewake official website has relevant firmware upgrades, the user may upgrade the product firmware via the Updater_BENEWAKE software. Please contact us to get the Updater.

The tools for the firmware upgrade of TF02-Pro-W are mostly the same as QUICK TEST GUIDE, which requires one TTL-USB board to connect the TF02-Pro with PC. The upgrade process is as follows:

- 1) Run Updater_BENEWAKE.exe, Select right port, here is “①COM9”. Input the right baud rate in “② 115200” and click “③ CONNECT” to connect the TF02-Pro-W with the software. As shown in Figure 6-1.

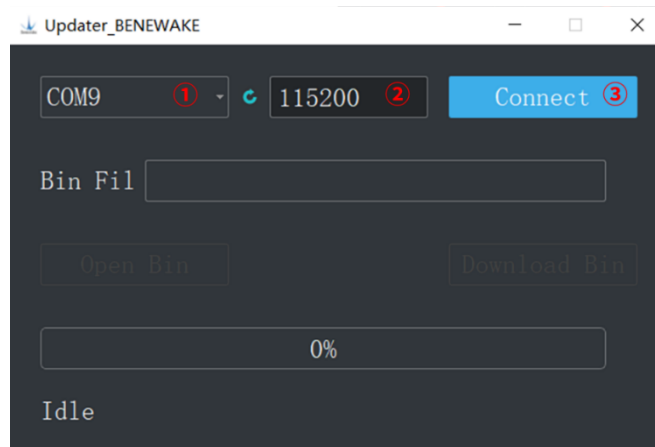

Figure 6-1 Connect the TF02-Pro-W with the software

- 2) Click “④ Open Bin” to choose the updating firmware, the message “⑥Read bin done” will be displayed after the file is uploaded. Then click “⑤ Download Bin” to start upgrading. As shown in Figure 6-2.

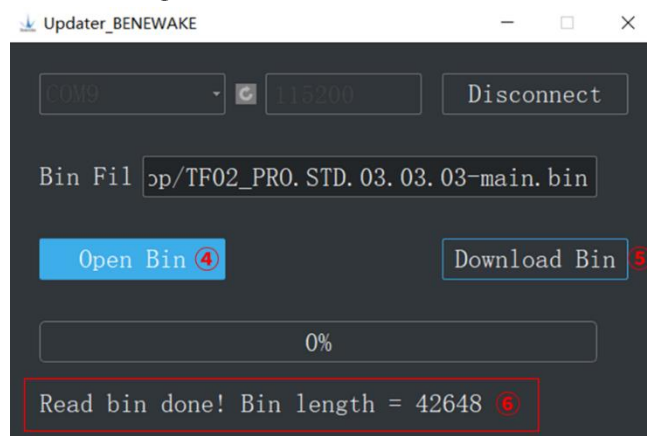

Figure 6-2 Upload firmware file

- 3) Check the status of the progress bar, 100% indicates that the upgrade is complete, and

appear "⑦Jump done".

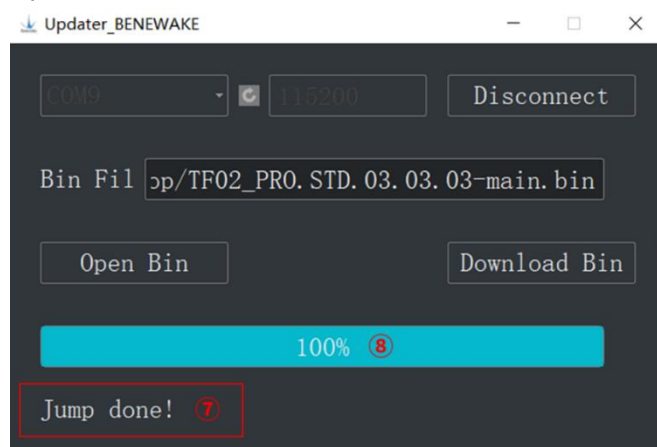

Figure 6-3 Upgrade is complete

7 Q&A

Q1: Is TF02-Pro-W available with other power supply voltage?

A1: Sorry, it is not available for the time being. The standard power supply of TF02-Pro-W is 4.8V~5.5V. If you have any further requirement, please contact our sales to consult a customization design matter, or you can obtain information about TF02-Pro-W-485, which supports 7V~30V about power supply.

Q2: Is it possible to change the FoV?

A2: Hello, this demand needs to be customized, please contact our sales to consult a customization design matter.

Q3: How far can TF02-Pro-W serial port version be transmitted? Can I extend the cable directly to increase the transmission distance?

A3: Hello, the effective transmission distance of TF02-Pro-W serial port data transmission is about 2m. If you need longer distance data transmission, it is recommended to convert the serial communication to other communication such as RS-485, and then extend the data line for transmission.

Q4: How long is the life of product?

A4: The warranty period is one year and can be used for more than 3 years under normal circumstances, the life of servo is larger than the product itself, the life of wiper is about 3 years under default mode (work every 4 hours), the wiper is made of rubber and it's a replaceable accessory.

Q5: Can TF02-Pro-W support RS-485 interface, analog signals output and Modbus protocol?

A5: TF02-Pro-W currently does not support interfaces other than UART and IIC. For RS-485 communication interface and Modbus protocol, refer to TF02-Pro-W-485. If there are related requirements, please contact our sales to consult a customization design matter.

Attachment-1 BW_TFDS software

BW_TFDS software only supports the Windows operating system. It is suitable for any products of TF series, but the output of those products is limited to the serial port communication protocol. Detailed operations are as below.

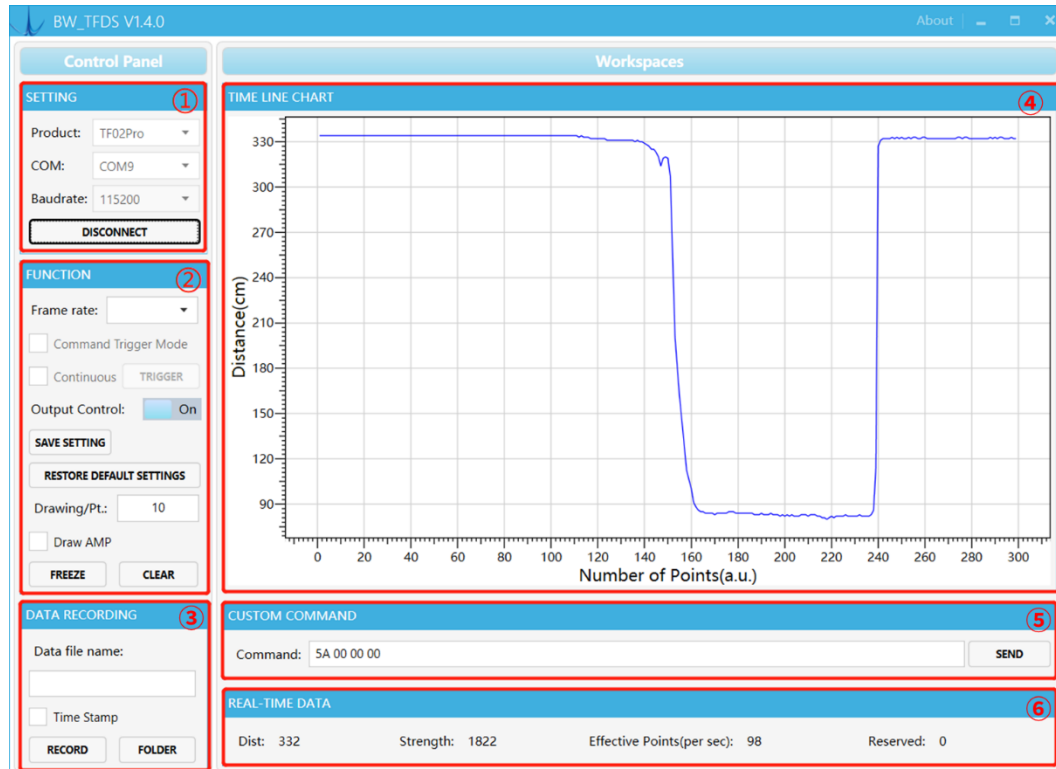

Figure 0-1 BW_TFDS software GUI

1) Product Type/Serial Port Control Zone [SETTINGS]

Product: choose product model, such as TF02-Pro in this paper

COM: select the right serial port number corresponding to the LiDAR.

Baud rate: choose the baud rate of LiDAR, which is set to 115200 as default for BENEWAKE.

CONNECT/DISCONNECT: Click [CONNECT] button to establish the connection with LiDAR. Click [DISCONNECT] button to terminate the connection.

2) Function Zone [FUNCTION]

Frame rate: choose frame rate from the drop box, setting will be made immediately, and the change is viewed in [©Effective Points].

Output Control: enable/disable the data output of LiDAR, default “on”.

SAVE SETTING: save the frame rate and output setting. click “SAVE SETTING” to save the configuration after setting, otherwise the settings will not take effect.

RESTORE DEFAULT SETTING: restore the factory default Settings.

Drawing/Pt: upon receipt of every N frames, the software will draw one point on the chart

[4] the average of the N data. N can be modified depending upon the actual requirement (the value is preferable to be ≥ 10 to prevent the PC software from lagging). After entering the value, press “Enter” key on the keyboard to enable the setting.

Draw AMP: the software will draw the curve of signal strength on the chart [4], take effect immediately after button is selected.

FREEZE/CLEAR: After clicking [FREEZE], time-line chart in zone [4] will stop updating. On clicking [CLEAR], the plotted curve in [4] will be cleared.

3) Data Recording Zone [DATA RECORDING]

Input the name of data file in the textbox. Press [RECORD] button to start recording data and click the [FINISHED] button to stop recording. Click [FOLDER] button to open the folder where the data file is saved.

4) Time Line Chart Zone [TIME LINE CHART]

The PC software will draw the continuous distance measurement curves based on the received data, where y-coordinates represent the current distance data while x-coordinates represent effective data.

5) CUSTOM COMMAND ZONE [CUSTOM COMMAND]

Command: Input the commands in hexadecimal format in the text box and click the [SEND] button above to send the command.

6) Real-time Data Display Zone [REAL-TIME DATA]

Dist: Distance, unit: cm by default.

Strength: the signal strength, values are between 0 and 65535.

Effective Points (per sec): indicates effective points refreshed by TF per second (equals to frame rate).