

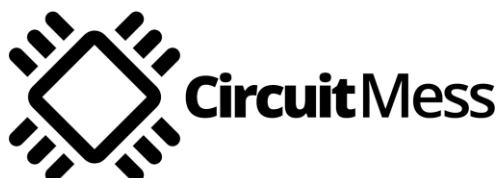

This is a printable version of the online MAKERbuino build guide from <https://www.makerbuino.com/build/>

Copyright CircuitMess © 2017. All rights reserved



MAKERbuino



# CHAPTER #1

## Adventure begins

### Welcome!

Welcome to the MAKERbuino build guide. In these 6 chapters, we'll help you make a fully functional retro gaming device out of a bunch of component's you've received in your MAKERbuino package.

### Age group

Our estimation is that an 11-year-old kid should be able to assemble the MAKERbuino with a tiny bit of help from an adult. Therefore, **the estimated age group is 11+**.

Estimated build time: **4 hours 30 minutes**. Build time varies and depends on the skills of a user.

MAKERbuino was made with the purpose of bringing STEM (Science, Technology, Engineering, and Mathematics) to electronics rookies in a fun and interesting way.

Despite that, it is not the simplest kit out there and if you've never soldered before, you should think about doing some preparatory practice or watching a couple of how-to-solder tutorials before you get down to business.

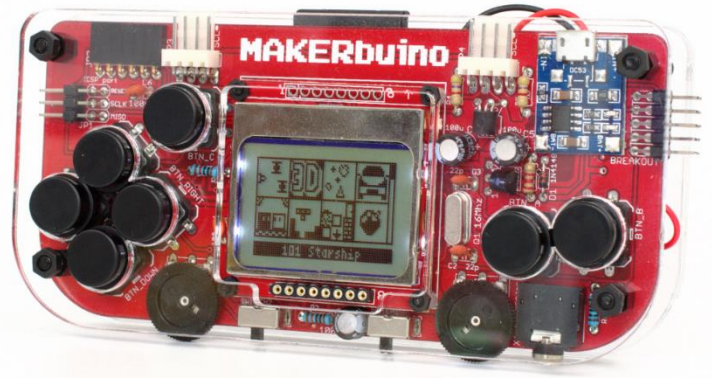

### Skills That Will Ease the Process of Assembling the MAKERbuino:

- Basic soldering experience (some preparatory experience)
- Ability to recognize the basic electronic components

If you do not have these skills, don't worry – you're a fast learner and you'll learn them in no-time.

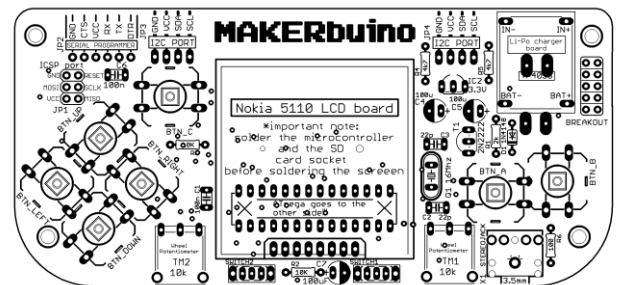

### What You'll Learn With the MAKERbuino

MAKERbuino's main goal is to educate and motivate you to learn something new or brush the skills you already have.

In the process of making the MAKERbuino you'll learn:

- How to solder
- What are the basic electronic components and what is their function
- How can electronic components be connected and why
- What are microcontrollers and some basics of digital electronics

What will you learn if you decide to code your own software for the MAKERbuino and expand it's hardware by connecting modules and components as expansions:

- How to program a microcontroller in C/C++
- how a simple video game works
- how to interface a microcontroller with external peripherals

## Basic resources

Here you can find MAKERbuino's schematics which might help you if you're already "into electronics". If you do not know how to read electronic schematics, don't worry – you'll learn!

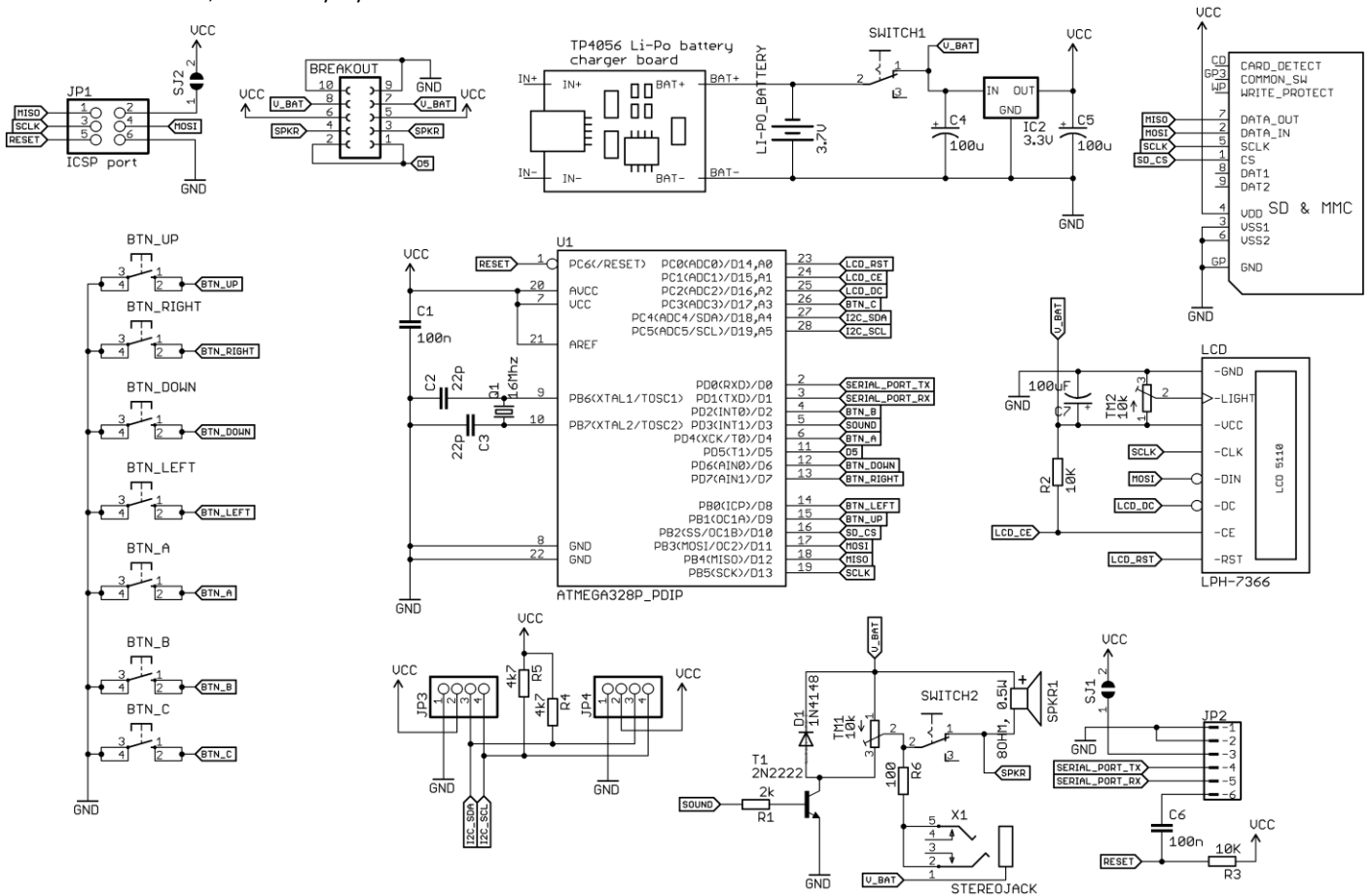

You might also find this diagram useful:

# MAKERbuino diagram

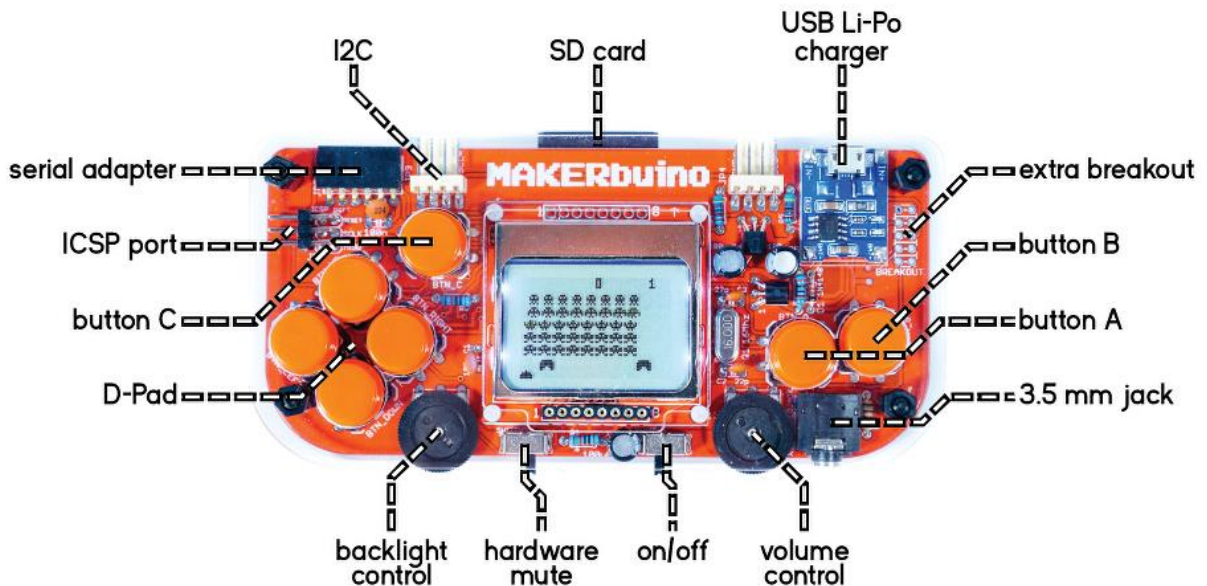

## What's in the box?

You've got your MAKERbuino box, awesome! Thank you for supporting our project!

**First of all, follow the list of included components and the text below and make sure that you have all the required components laid out on your table and ready for soldering.**

If something from the list is missing, please tell us via [contact@makerbuino.com](mailto:contact@makerbuino.com). Your MAKERbuino was hand packed with love in Croatia by us (humans), and humans make mistakes, so everything's possible.

## List of components

Here you can find a table of your kit's content.

The content of your kit may vary depending on the type you've bought (i.e. the kit with tools comes required tools and the inventor's pack has some extra inventor's components included).

**If you do not know what every single one of these components looks like, please don't worry, we'll cover every component and its purpose in the following section after the table of content.**

Label	Component Name	Quantity
NO LABEL	MAKERbuino PCB	1
NO LABEL	laser cut acrylic casing (consists of 3 pieces)	1
NO LABEL	M3 nylon screws	4
NO LABEL	M3 nylon nuts	4
NO LABEL	M3 6mm nylon hex distancer	8
NO LABEL	M2 nylon screws	2
NO LABEL	M2 nylon nuts	2
NO LABEL	M2 nylon spacers	2
NO LABEL	128MB Micro SD card + SD adapter	1
NO LABEL	SD socket	1
NO LABEL	pair of tiny RED and BLACK insulated wire for connecting the speaker	1
NO LABEL	8ohm 0.5W speaker - 28mm diameter	1
NO LABEL	Li-Po battery (650mAh, single cell - 3.7V) with male JST connector	1
NO LABEL	female JST battery connector (should already be mounted on the board)	1
NO LABEL	USB to RS232 adapter board (serial programmer)	1
NO LABEL	6-wire male to female cable for connecting the serial adapter board	
U1	ATmega328P-PU microcontroller in PDIP package	1
NO LABEL	28 pin PDIP IC socket (for the ATmega328P)	1
LCD	Nokia 5110 LCD breakout board	1
NO LABEL	TP4056 micro USB Li-Po battery charger board	1
IC2	3.3V voltage regulator (MCP1702-3302E in TO-92 package)	1
T1	2n2222 general purpose NPN transistor (TO-92 package)	1
Q1	16MHz crystal	1
D1	1N4148 diode	1
SWITCH1, SWITCH2	3 pin slide toggle switch	2
C1, C6	100nF ceramic capacitor	2
C2, C3	22pF ceramic capacitor	2
C4, C5, C7	100uF, 6.3V radial electrolytic capacitor	3
BTN	12x12x7.3mm pushbutton with button cap	7
JP1	standard double row 3x2 pin angle headers (male) - for SPI port	1
JP2	standard single row 6 pin angle headers (female) - for Serial port	1
JP3, JP4	KF2510-4P angle male connector - for i2c expansion ports	2
BREAKOUT	standard double row 5x2 pin angle headers (male) - for breakout port	1
TM1, TM2	1Kohm wheel trim potentiometer	2
R1	2.2Kohm resistor	1
R2, R3	10Kohm resistor	2
R4, R5	4.7kohm resistor	2
R6	100ohm resistor	1
X1	3.5mm headphone connector socket	1

## Detailed description of the components

### MAKERbuino's PCB

PCB stands for printed circuit board.

Basically, this is a board with some copper traces and some other components like protective paint and insulating material.

Copper layers on the board form traces that connect various MAKERbuino's electronic components (e.g. they connect the microcontroller to the screen) so that they can work together as an electronic device.

This is an equivalent to your PC's motherboard.

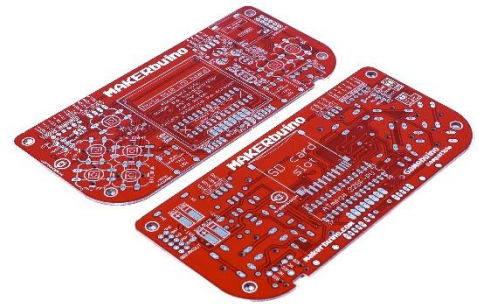

### Laser Cut Acrylic Casing

MAKERbuino's circuitry is protected by a casing made out of laser cut plastic (they're made on a CNC laser cutting machine).

The casing consists of 3 pieces (see the picture). Your MAKERbuino's casing is crystal clear, we've painted the board red in the picture for better visibility.

One piece is used to protect the front (top) side of your MAKERbuino device and the other two pieces protect MAKERbuino's back.

Everything is stacked one on another using nuts, bolts and plastic spacers. This style of casings is called "the sandwich design".

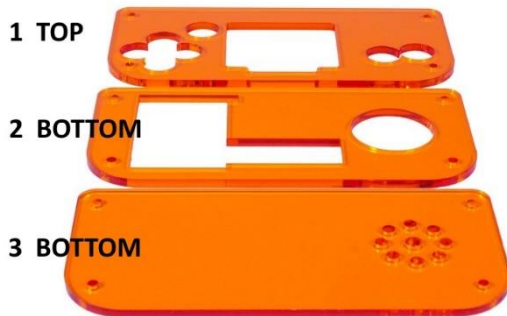

### Nuts, bolts, spacers

These basic mechanical components are needed for fixating the screen and the casing to the circuit board.

M3 or M2 in the name of the screws indicates that their shaft's diameter is 3 mm or 2 mm accordingly.

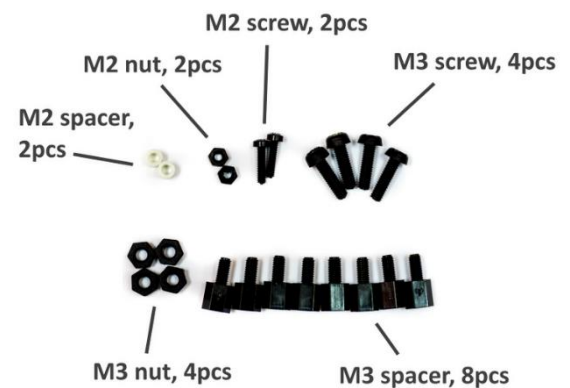

### Li-Po battery

The rechargeable battery serves as MAKERbuino's main power supply.

650mAh is more than enough for several hours of intense gaming and powering all sorts of power-hungry expansion modules (like GPS receivers, motors, wifi modules, etc.).

In case you didn't know, "Li-Po" in the name of the battery indicates its structure and what materials it uses to store electrical energy (Li-Po stands for Lithium Polymer).

It comes with the male JST power connector (the white connector at the end of the red-black cable) that is then connected to the female JST connector soldered directly to the board.

**Electronics 101: the positive pole of any electrical power source (+) is usually marked with a red wire. The negative pole of any electrical power source (-) is usually marked with a black wire (in some cases green and brown color is used too).**

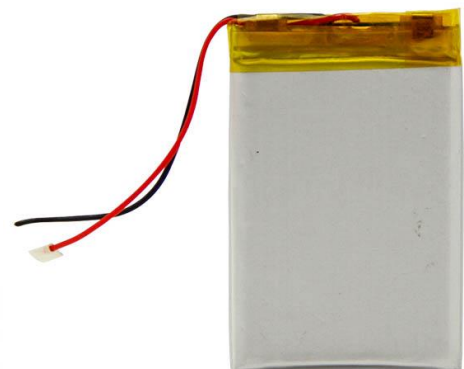

## Female JST connector

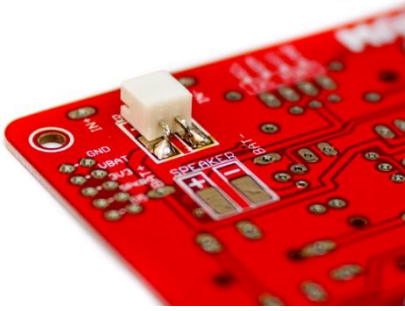

This connector is pre-soldered to MAKERbuino's PCB and is used for connecting the Li-Po battery to the circuit.

These white JST connectors are different from regular connectors in a way that **they are anti-reverse**. In other words, you cannot swap polarity while connecting the battery. This is important because reverse polarity can damage MAKERbuino's charging circuit.

## Important: the "sandwich"

Some of the above components (PCB, casing, some nuts and bolts, female battery connector, Li-Po battery) might come packed in this sandwich-like form displayed on the picture.

The reason for sending you those components like that is a regulation that doesn't allow us to send the Li-Po batteries via airmail if they are not embedded in some kind of a "device".

Before assembling the MAKERbuino, you will have to unscrew the sandwich and release the PCB so that you can solder the components on it.

**Electronics 101: never solder or modify a device that is "alive". In other words, always unplug the battery or some other power supply from the device's PCB, otherwise, you might make a short circuit with your soldering iron or screwdriver and damage the electronic components.**

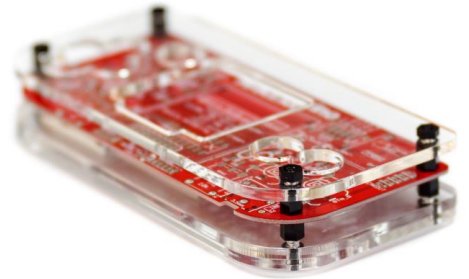

## RS232 Serial UART adapter & the corresponding 6 pin cable

This red Serial adapter board is connected to MAKERbuino's serial port (top left black female angle connector).

It allows you to program your MAKERbuino directly from your computer and send all sorts of useful data from the computer to the MAKERbuino and vice versa.

**The board is connected to the MAKERbuino with a 6-pin rainbow female to male cable.**

You won't need these components in the basic assembly so you can put them aside for now.

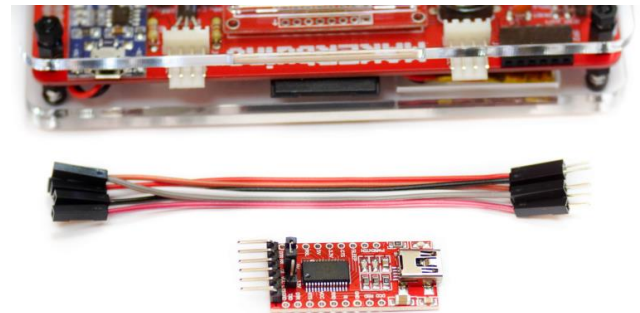

## SD card (microSD + SD adapter)



The included SD card is used for storing games, programs and other useful data on it (game graphics, music etc.).

Thanks to this card, you can load multiple games on your MAKERbuino.

**It comes preloaded with lots of fun games downloaded from the games gallery so that you can try it out right after you assemble it.**

You might be wondering why the card's capacity is only 128 MB. This is an 8-bit gameboy-like gaming device and programs and games for it are approximately 30 kB. Thus, 128 MB of space will be more than sufficient for storing plenty of games, programs and useful info.

## Speaker

This neat little speaker fits at the back side of the device, it has a special place in the back of the casing.

**It plays a crucial role in producing all the beeps, boops and crazy chiptunes you'll compose in your very own games.**

Power: 0.5W, Impedance: 8Ω, Body dimensions: Ø28 x 4.7mm

Note: speaker's photos are made by [www.tme.eu](http://www.tme.eu)



## ATmega328p-pu microcontroller + 28-pin socket

The ATmega microcomputer (aka. microcontroller) is the brain of the device.

It has CPU, RAM memory, flash memory and almost all parts needed for executing programs and games and doing all the smart work.

Basically, this is a computer in a chip. ATmega328's astonishing 2kB of RAM and an 8-bit CPU at 16MHz of frequency will bring out the nostalgia and provide you with the authentic old school retro experience.

It comes with a dedicated 28 pin socket for easy microcomputer replacement.

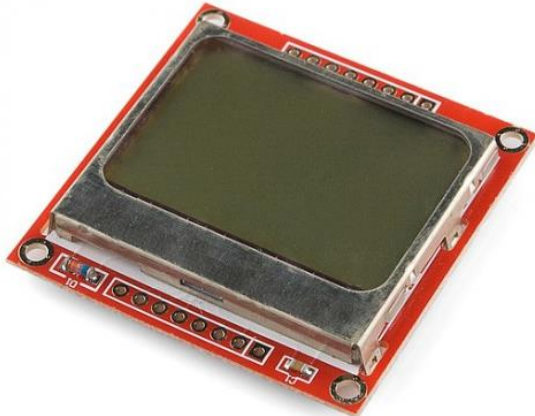

## Nokia 5110 LCD screen

The screen module is an LCD screen on a breakout PCB.

**LCD stands for liquid crystal display. This is a screen that is controlled by the main ATmega microcomputer.**

It's a graphical display so you can manipulate every pixel's color with a program in the microcomputer.

The complete module is stacked on the main MAKERbuino PCB.

The screen **has some magnificent features like high resolution** (84x48 pixels monochrome), **adjustable LED backlight** and **great visibility in direct sunlight** (the display works in the same way as your calculator's display – can be viewed without the backlight if there is enough light in the room).

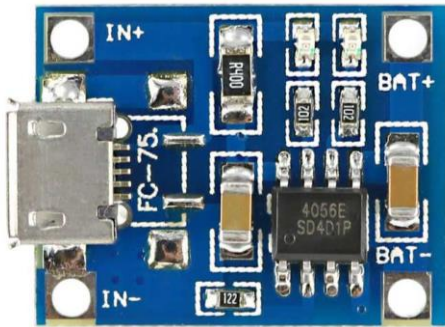

## TP4056 Li-Po Battery Charger Board

This module is used for charging the rechargeable Li-Po battery.

It's actually a separate PCB that is stacked and soldered on the main MAKERbuino board.

**The most important part of the module is the TP4056 charger integrated circuit (the little black chip on the board).**

It's regulating voltage and current of electricity inputted by the USB port and feeding it to the Li-Po battery.

It has a **micro USB port** so that you charge your MAKERbuino with the most common mobile phone charging cable.



## 3.3V Voltage Regulator (MCP1702-3302ET)

This 3-leaded component regulates the voltage from the Li-Po battery to stable 3.3V. **We need to do that because the battery's 3.7V of electricity is just too much for MAKERbuino's circuitry and would fry the SD card.**

Most people say, hey this is a transistor... **no, this is not a transistor.**

**This particular shape of an electronic component is called the TO-92 package and it looks the same as the 2N2222 transistor listed below (this transistor's creators decided to use the same package).**

**The only difference between the 2N2222 transistor and this voltage regulator is the text written on the component.**

The regulator should have MCP1702-3302ET written on its surface, whilst the transistor will have 2N2222 written on its back. Use a magnifier if needed and check carefully if you have the right component.

**When soldering the regulator, be extra cautious not to accidentally swap it with the transistor.**

## 2N2222 General Purpose NPN Transistor

The general purpose transistor is used in the part of the MAKERbuino dedicated to producing sound.

The transistor serves as an amplifier that drives the console's speaker.

As said when describing the regulator above, don't let the shape of this component trick you, this is not a regulator (mind the tiny "2N2222" or "KSP 2222A – 708" written on it!).





### 3.5mm headphone connector socket

This is a standard headphone connector socket used on most devices' audio output channels. You can connect your regular headphones to this connector to hear all the amazing bleeps and bloops your MAKERbuino synthesizes.

### 16MHz Crystal

Inside this metallic package is a crystal used in MAKERbuino's microcomputer's oscillator circuit.

In other words, MAKERbuino's neat 16MHz of CPU clock is possible thanks to this component.

Standard digital clocks and watches work on the same principle.

**IMPORTANT:** Text marking on the crystal may vary and sometimes look like this: "16B000"



### 1N4148 Diode

This is a standard diode.

It's used in MAKERbuino's sound circuit.

**This is NOT a light emitting diode (LED), it doesn't light up, it's used as an essential part of the sound's circuit amplifier.**



### 3 Pin Toggle Switches (2 pcs)

These 3-leaded standard electromechanical switches are used for turning your MAKERbuino ON and OFF and muting the speaker.



### Capacitors

There are three different types of capacitors in your MAKERbuino kit

### 100uF Electrolytic Capacitors (3 pcs)

These look like small black barrels with two leads. **They're used for filtering noise and ensuring that MAKERbuino's circuitry is powered with clean and stable electrical current.** These capacitors should have 100uF written on their surface. Unlike other capacitors in the kit, these are polarized.

**Electronics 101: only electrolytic capacitors are polarized and have significantly higher capacity compared to other capacitors.**







### 100nF ceramic capacitors (2 pcs)

The tiny yellowish capacitor with 104 written on it is a 100nF capacitor used for filtration and for digital reset via the serial adapter board.



### 22pF ceramic capacitors (2 pcs)

These capacitors are used as a part of the 16MHz oscillating circuit along with the previously listed crystal. They look similar to the 100nF capacitors so don't let that trick you. **Recognize them by number 22**(symbolizing that they have the capacity of 22pF) **written on their surface.**



### pushbuttons & button caps (7 pcs)

Nice and clicky big square push-buttons are pretty self-explanatory. They're MAKERbuino's **essential input devices** used for switching menus, changing programs, playing games... Button caps are just simply attached to the button's top side and can be changed. **You can buy some extra colored button caps in our webshop.**

## Various pin headers and connectors

All these pins and headers are used for connecting various modules, expansions, and programmers to your MAKERbuino board. There are four types of connectors included in the MAKERbuino kit:



### 6 pin angled female header

This tiny black connector is used for connecting your MAKERbuino to the serial UART programmer board (important for programming the console).



### 2x3 male angled ICSP header

Used for connecting expansion modules and an ISP programmer for reprogramming the game console's microcontroller over ICSP (in circuit system programming) protocol.

### 2x5 male angle extra breakout header

The 10 pin double row angle header is soldered to the rightmost part of the game console and is an extra option that gives you some extra useful pins for connecting hardware expansions.



## KF2510 4-pin anti-reverse angle headers for i2c ports (2pcs)

These connectors go to the top side of the device and are used for connecting expansion modules and other MAKERbuino's or Gamebuino's (**multiplayer games!**). They're just like all other connectors but with a special anti-reverse function so that you can't swap the polarity and short circuit your game consoles when connecting them with the multiplayer link cable.



## 1k ohm wheel trim potentiometers (2pcs)

Wheel potentiometers are very important for **regulating the screen's backlight and dimming the sound volume**. The potentiometers have B102 written on their back indicating that they have 1Kohm of resistance ( $10 * 10^2$  ohms).

## Resistors

Resistors are **standard passive two-lead electronic components that implement electrical resistance as a circuit element**. The resistors are used in MAKERbuino for all sorts of important tasks like **adjusting signal levels and regulating current flow**. Every resistor's resistance is measured in **ohms**.

You can determine the resistance of a resistor by using color code – reading a set of colored rings on the resistor.

**There are four types of resistors used in the MAKERbuino kit:**

- **100 ohm resistor x1**

This one is used when outputting sound to MAKERbuino's headphone jack.  
Color code: brown, black, brown, golden  
(\*in some versions of the MAKERbuino kit, these resistors might be labeled like this: brown, black, black, black, brown or golden)

- **2.2k ohm resistor x1**

This one is important for driving the transistor in the MAKERbuino's sound circuit.  
**Color code: red, red, red, golden**

- **4.7k ohm resistor x2**

These resistors are used as pull up resistors on i2c lines (multiplayer and expansion ports).  
**Color code: yellow, purple, red, golden**

- **10k ohm resistor x2**

These are important for driving the LCD screen and connecting the microcontroller to the serial UART programmer (for connecting the MAKERbuino to your computer).  
**Color code: brown, black, black, red, golden**

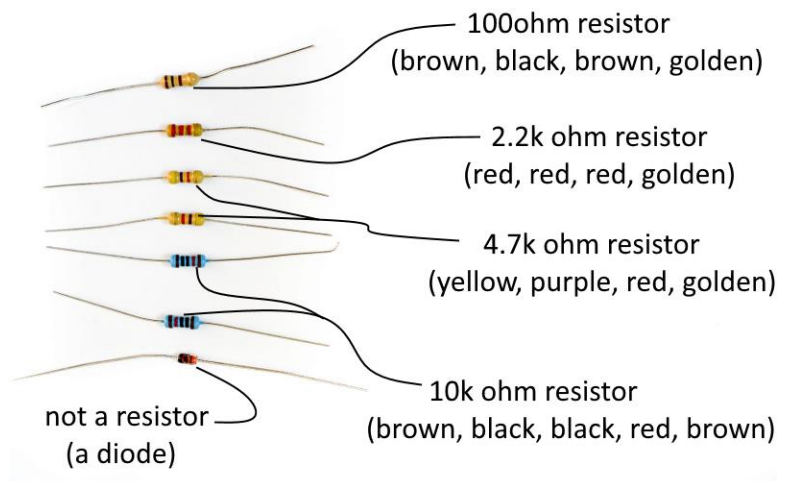

**Electronics 101:** reading resistor's color code is quite easy, you just have to follow a color code table like this one over here. Alternatively, you can also use a resistor color code calculator tool like this one: [color code calculator](#). Every pro maker has to know this resistor table by heart, and it's quite easy using this interesting technique from [resistorguide.com](#) – you just have to remember this sentence: **Bad Beer Rots Our Young Guts But Vodka Goes Well Get Some Now!**

www.resistorguide.com

	Color	Significant figures			Multiply	Tolerance (%)	Temp. Coeff. (ppm/K)	Fail Rate (%)
Bad	black	0	0	0	x 1		250 (U)	
Beer	brown	1	1	1	x 10	1 (F)	100 (S)	1
Rots	red	2	2	2	x 100	2 (G)	50 (R)	0.1
Our	orange	3	3	3	x 1K		15 (P)	0.01
Young	yellow	4	4	4	x 10K		25 (Q)	0.001
Guts	green	5	5	5	x 100K	0.5 (D)	20 (Z)	
But	blue	6	6	6	x 1M	0.25 (C)	10 (Z)	
Vodka	violet	7	7	7	x 10M	0.1 (B)	5 (M)	
Goes	grey	8	8	8	x 100M	0.05 (A)	1(K)	
Well	white	9	9	9	x 1G			
Get	gold			3th digit only for 5 and 6 bands	x 0.1	5 (J)		
Some	silver				x 0.01	10 (K)		
Now!	none					20 (M)		

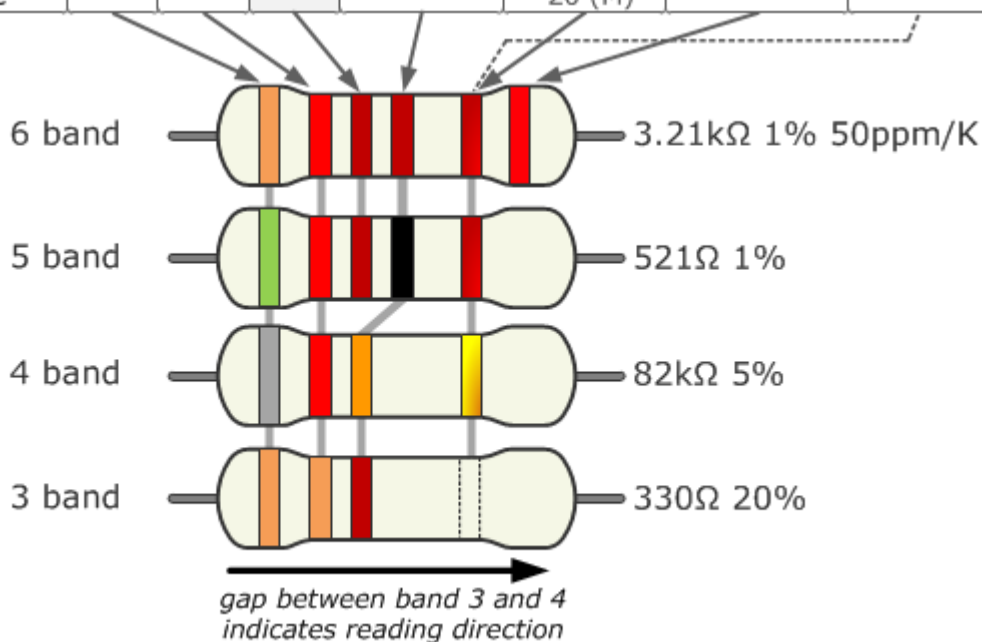

## CHAPTER #2

Let's quickly cover the basic tools and material you'll need for assembling your MAKERbuino

**You've carefully read the previous section and checked that you have all the components, good job!**

There are some tools and equipment that are required for the assembly and they are not included in the standard kit.

**If you've bought the standard kit (not a kit with tools) and don't have them, now would be a good time to borrow or purchase them.**

These tools are useful whenever assembling, fixing or modifying electronic devices and should be the part of every maker's/hacker's/modder's/electrician's equipment.

Many of these are available in a supermarket or in some professional DIY electronics stores like Radio Shack, Adafruit, Sparkfun....

### Soldering iron



Any entry level 'all-in-one' soldering iron that you might find at your local hardware store should work (recommended power – something around 30W).

It's a good idea to upgrade to a more expensive soldering station with temperature regulation if you plan to dive into the world of DIY electronics more thoroughly.

### Solder

We highly advise buying a rosin core, 60/40 solder.

This type of solder is usually preferred by the DIY electronics community for similar soldering projects.

Be careful when buying solder, bad solder leads to lots of complications like bad solder joints and unwanted bridging.



### Diagonal Cutter Pliers



You'll need pliers like this to trim leads of soldered components and cut wires. We prefer this type showed on the picture (Plato, model 170).

### Standard cross screwdriver

You'll need this one to mount the casing and the LCD screen. A regular cross screwdriver with a shaft diameter of 3mm or smaller is sufficient.



## Some insulating tape

You'll need some sort of adhesive to fixate MAKERbuino's speaker to the back side of the casing.

**Our advice:** some insulating or similar tape is the best choice here, but a tube of superglue or a hot glue gun will also do the job. Although, it will not look as tidy as it could if you've used the tape for fixation.

## Extra: tools that are not mandatory for assembling the MAKERbuino but might come in handy

Here are a few tools that will prove useful if you plan to do some more making after you make your MAKERbuino:



### Desoldering vacuum tool (aka. solder sucker)

This tool is useful in cleaning up soldering mistakes but is not 100% necessary for assembling your MAKERbuino.

If you plan to do some hacking, modding, or any kind of hardware repair or rework in the future, buying this one is a good idea.

## Helping third hand with magnification

This one is also not necessary but will make your life (...and soldering) much easier when it comes to assembling and/or repairing devices more complicated than the MAKERbuino.



### Multimeter

It will prove useful for testing some tricky connections and measuring supply voltage. Besides that, a good multimeter can help you test resistors, transistors, diodes, capacitors, measure the current and do all sorts of other useful things.

## Solder wick

You can use it along with the desoldering vacuum tool to clean up soldering mistakes. It will clean the excess solder from the places unreachable with a regular desoldering vacuum tool.



## CHAPTER #3

MAKERbuino, it's time to meet your maker! (pun intended)

### Soldering basics

Have you ever soldered before? If your answer is “yes”, you’ll probably know what you’re doing and you can just fastly skim through this intro paragraph.

**In case you’ve never soldered before, please take 10 minutes of your time and look at one of the following how-to-solder guides:**

- [Adafruit’s video tutorial featuring Collin Cunningham](https://youtu.be/QKbJxytERvg) - <https://youtu.be/QKbJxytERvg>
- [Adafruit’s standard soldering tutorial](https://learn.adafruit.com/adafruit-guide-excellent-soldering) – <https://learn.adafruit.com/adafruit-guide-excellent-soldering>
- [Sprakfun’s video soldering tutorial](https://youtu.be/f95i88OSWB4) – <https://youtu.be/f95i88OSWB4>
- [Sparkfun’s standard soldering tutorial](https://learn.sparkfun.com/tutorials/how-to-solder-through-hole-soldering) – <https://learn.sparkfun.com/tutorials/how-to-solder-through-hole-soldering>

**To sum all of these tutorials up**, making a good soldering joint is very important and can be quite easy if you follow this simple rule: your soldering joint has to look like a small “volcano” and mustn’t be a tiny ball or blob or soldering. A bubbly blob-like soldering joint is a sign of too much solder or a need of more heat (you have to resolder the joint).

All of this is shown on this awesome picture by Adafruit industries (thank you Adafruit!):

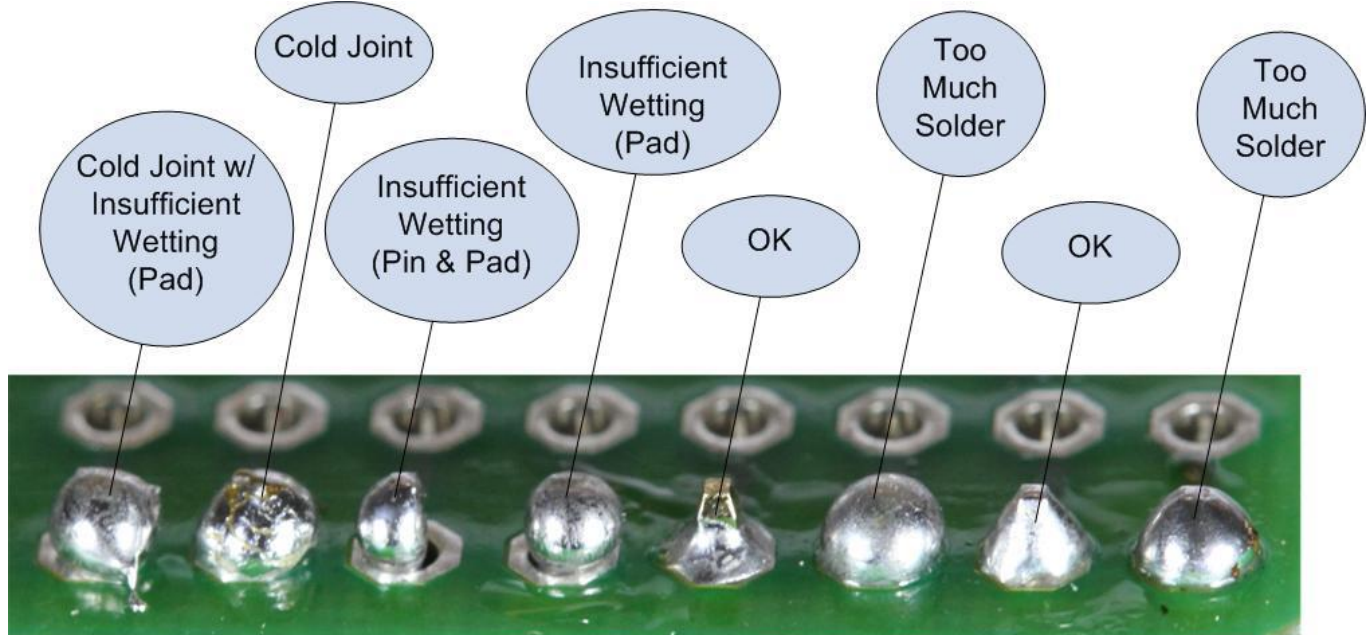

### Motivational tip from Albert (the guy that designed the MAKERbuino)

Soldering is an essential skill if you want to become an electronics ninja one day. Your soldering iron is a magical wand, only instead of enabling you to fight black magic, it gives you the power to create unique intelligent electronic devices from scratch.

Don’t get frustrated by soldering failure, it’s just a matter of practice. You’ll get better in it over time by soldering kits like MAKERbuino and working on other fun projects you decide to make. I know how frustrating it can be when something doesn’t work from the first try. The truth is, you’ll have to get used to it because you’ll get lots of that in the world of DIY electronics.

And please, don’t worry, In the worst case scenario (your MAKERbuino not working) we’ll make it work together.

Good luck and keep making!



## Pro tip:

We suggest that you start building the MAKERbuino when you're fresh because the process of assembly can take up to 5 hours depending on your soldering skills (in other words, don't start building it in 2AM)

## Step 1 – the SD socket

We'll start with the SD card socket – the big shiny metallic component that is mounted on the PCB's surface. Find the SD socket, place it on the back side of the board where there is "SD SOCKET" text written on it.

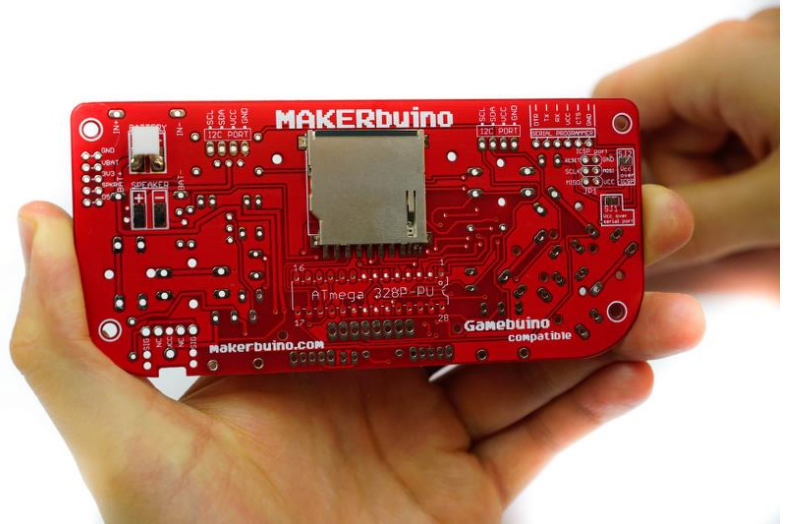

Continue by soldering the four pads of the socket's shielding.

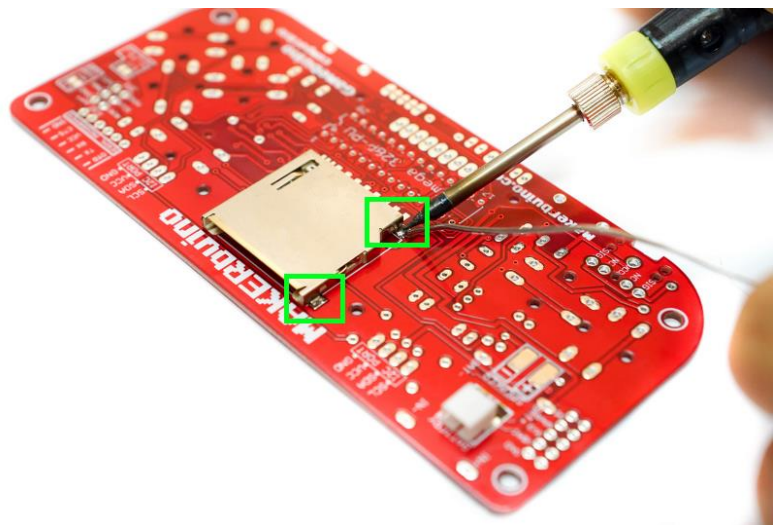

When soldering the socket's contacts, you DON'T have to solder the three rightmost pins because they are not used.



## Step 2 – Microcomputer's socket

Microcomputer's socket is also soldered at the back of the MAKERbuino board.

Be careful how you rotate the socket because it's not symmetrical. Be sure to place it on the right side indicated by a notch on the socket

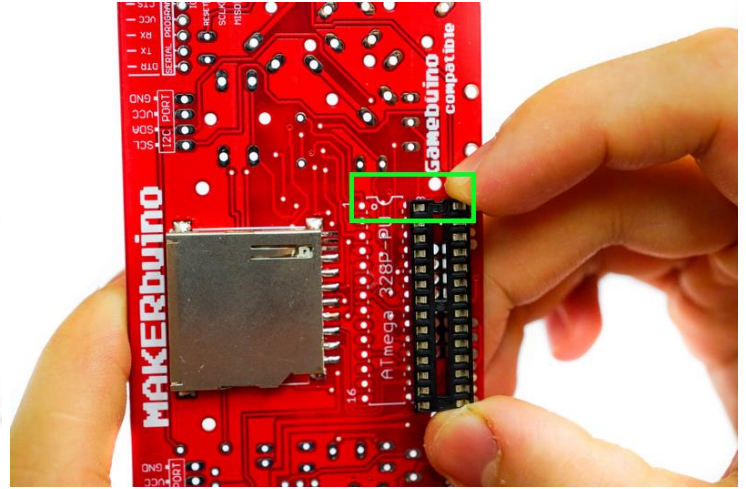

**pro tip:** first solder the two diagonal pins of the socket, then make sure that the socket is aligned with the board nicely, correct the alignment if needed and solder the rest of the pins.

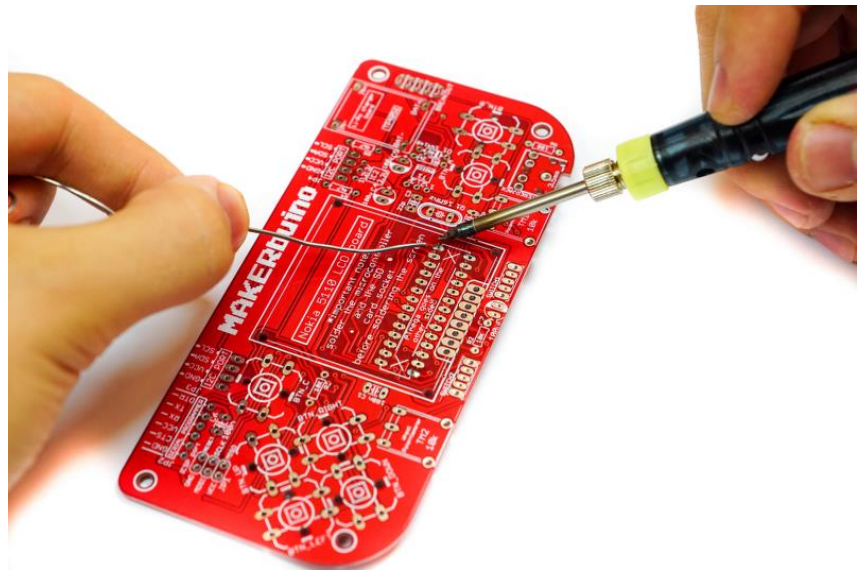

## Step 3 – 10k ohm resistor

Find the tiny 10kΩ resistor (colors: brown, black, black, red, brown) and solder it to the front side of the board where the R2 mark is (bottom side of the board) – this resistor is necessary for the screen to work.

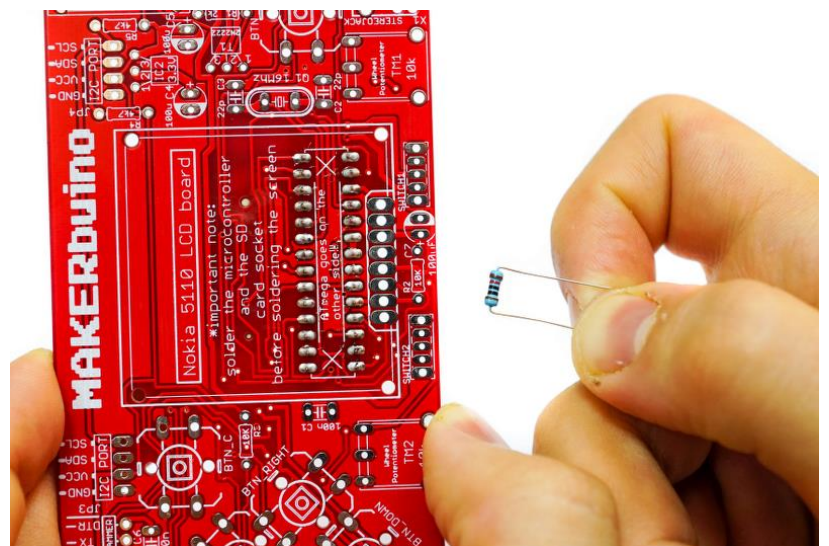
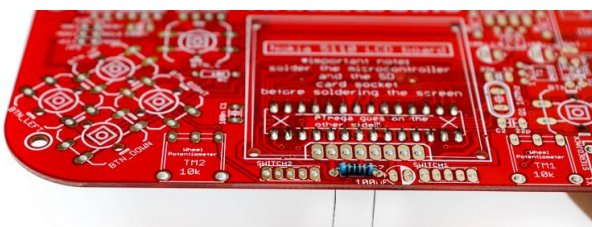



**Pro tip:** when you insert the resistor, bend the leads of the resistor so that it doesn't fall out from the PCB while you're soldering it.

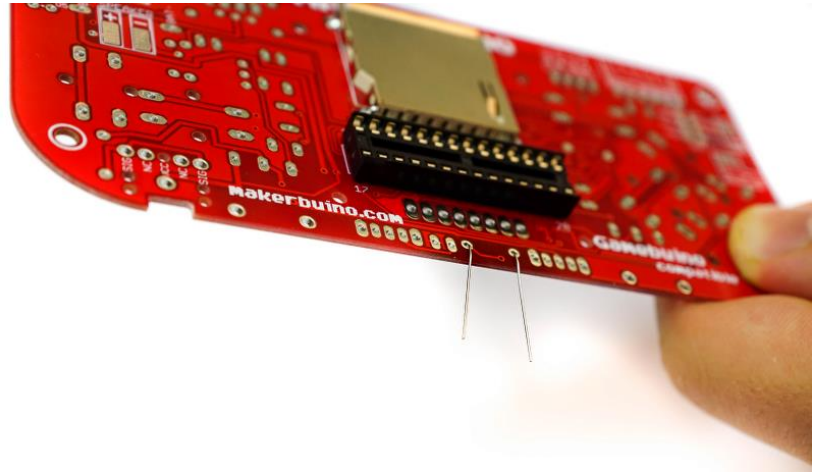

**Important:** Remember to cut all the leads of the components you've soldered using your diagonal cutter pliers. Also, **save the excess leads** you've cut, you'll need them in one of the further steps.

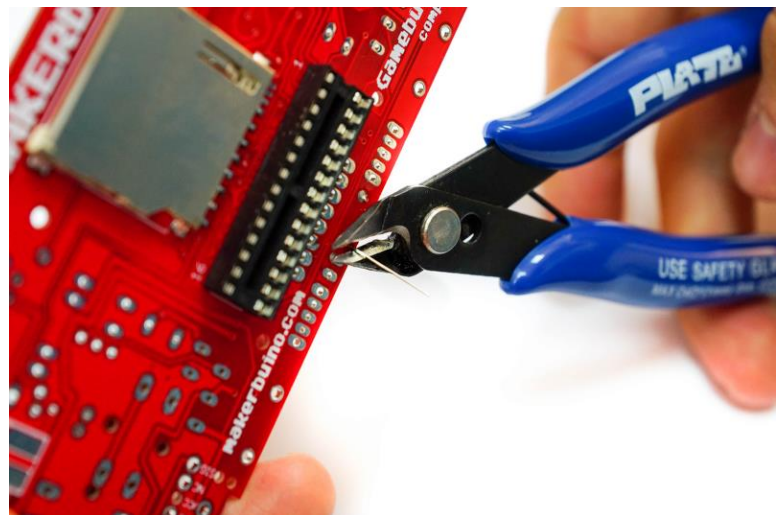

#### Step 4 – 16MHz crystal

Find the 16MHz crystal and insert it on the front side of the PCB (right half of the PCB, marked Q1, 16MHz).

**IMPORTANT:** Text marking on the crystal may vary and sometimes look like this: "16B000".

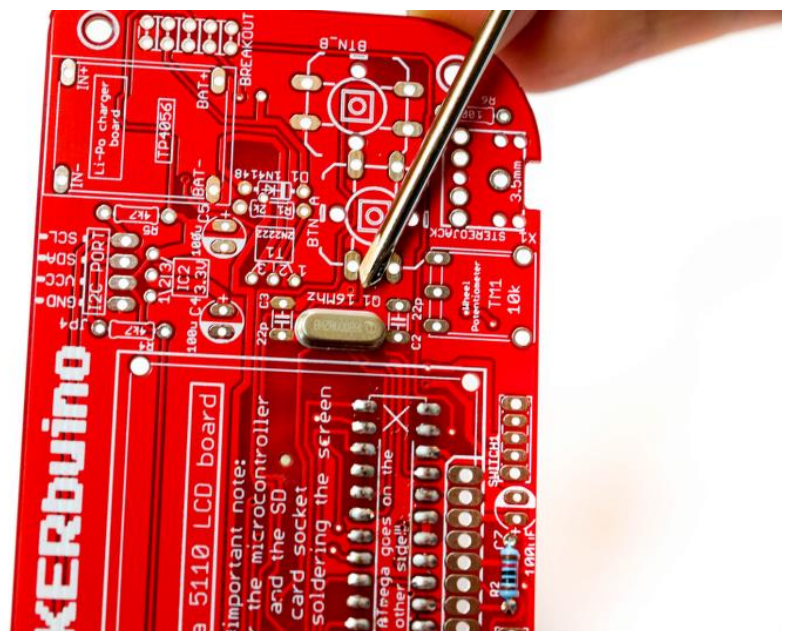

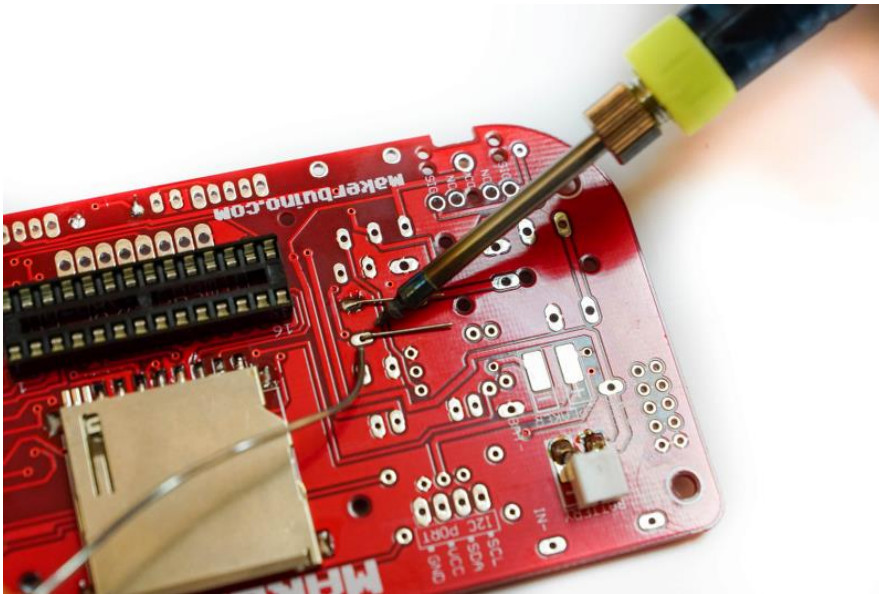

Apply the previous pro tip and bend the leads of the crystal at the back of the board.

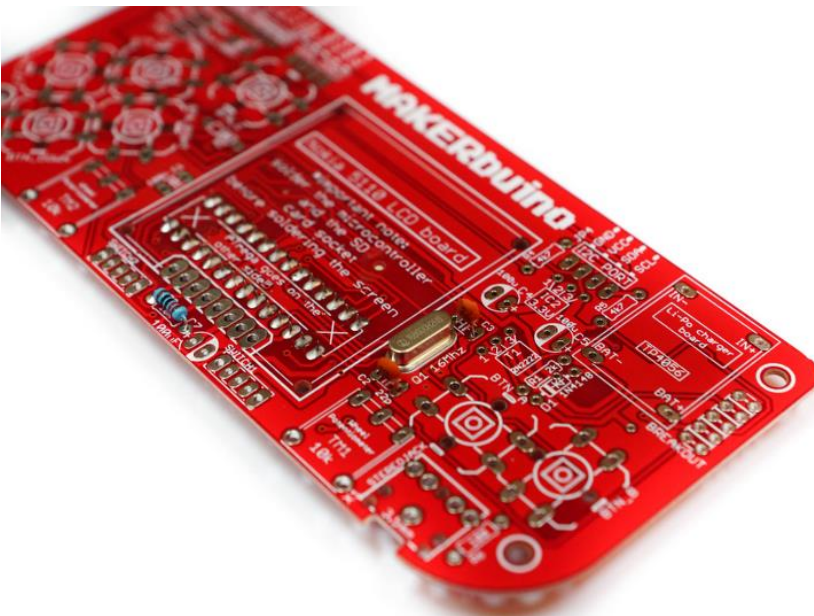

### Step 5 – two 22pF capacitors

Solder the two 22pF ceramic capacitors (little red-ish thingies with the number 22 written on them). Along with the crystal, these are essential for the oscillating circuit of the game console.



### Step 6 – two slide switches

Now solder the two slide toggle switches for turning the console ON and OFF and muting the sound. They're soldered at the bottom side of the PCB and labeled as SWITCH1 & SWITCH2.

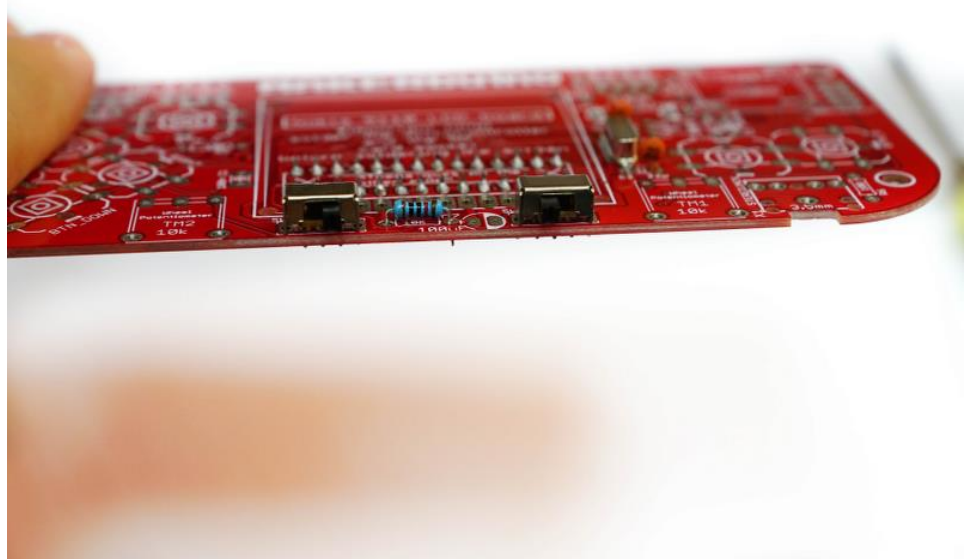
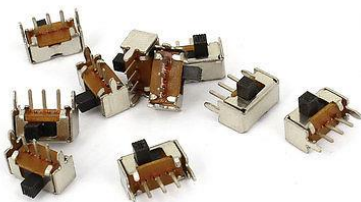

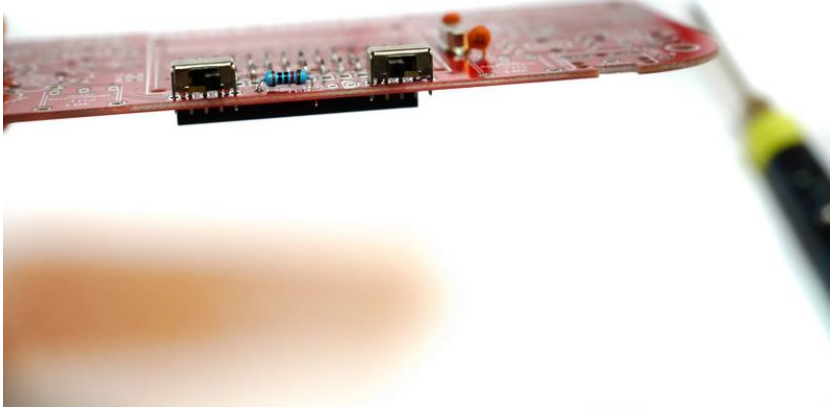

The left switch is muting the sound and the right one will turn the console's power ON & OFF. The switches have to go all the way down and sit nicely on the PCB.

## Step 7 – 100uF electrolytic capacitors

Locate the three electrolytic capacitors (tiny black barrels with two leads). The places for these are marked on the PCB as C4, C5 and C7.

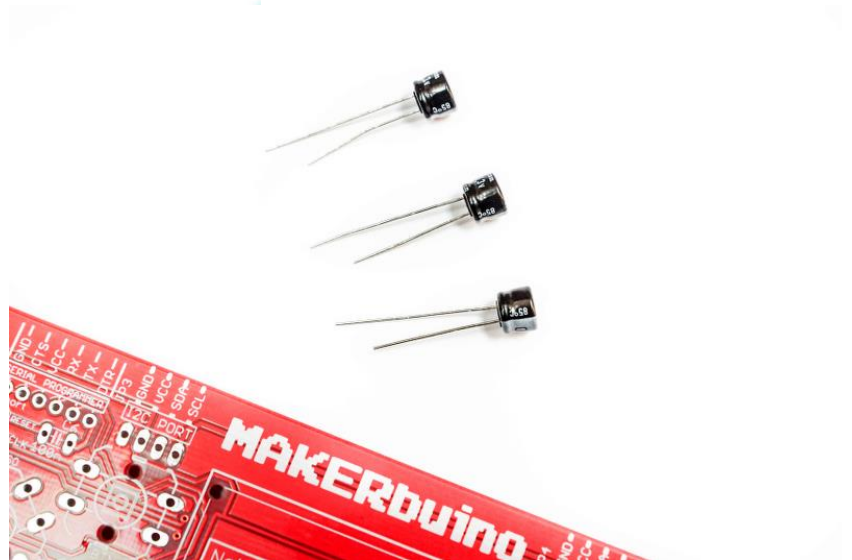

**Important:** these capacitors are polarized, make sure to insert them properly.

The polarity of the capacitors is indicated with the big white minus (-) sign on the capacitors (the big white stripe).

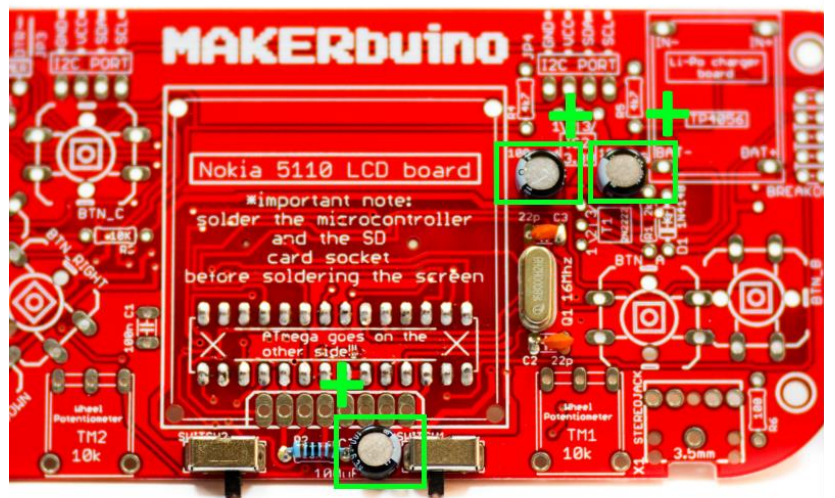

## Step 8 – 3.3V voltage regulator & 2n2222 transistor

**Important:** These two components are very similar so make sure to read the text on the components carefully because that is the only way you can recognize them.

(Please note that the text on your transistor may vary and have something like “KSP 2222A – 708” written on it. This happens because the different manufacturers tend to write unique serial numbers on their components)

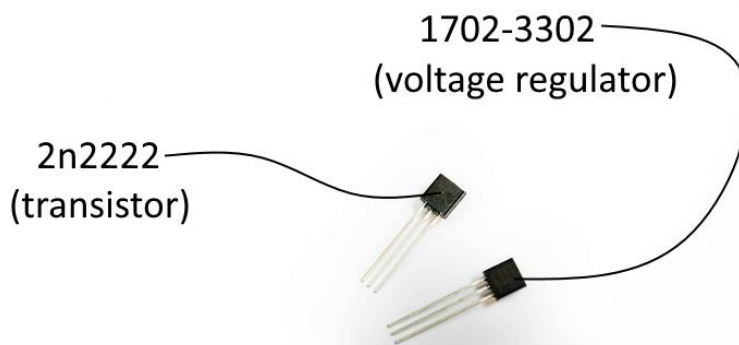

Solder the regulator on the board where “IC2 3.3V” is marked and the transistor to the spot with “T1 2N2222” marking on it.

**Be careful to turn these components on the right side!**

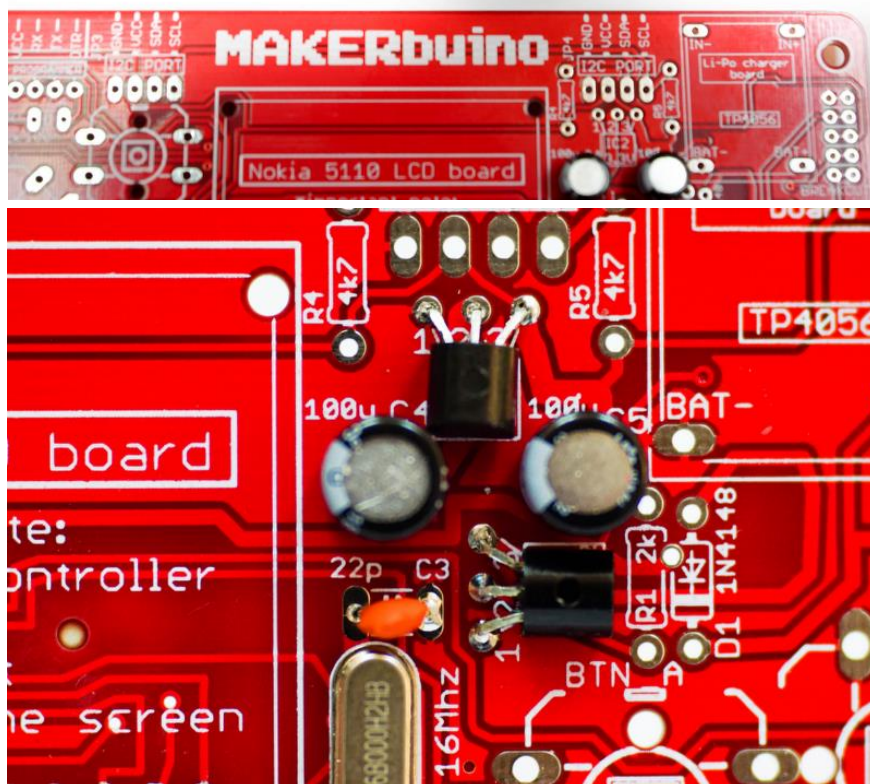

**Important:** Make sure the flat side of the regulator and the transistor faces down towards the board, this is achieved by bending the pins of the components by 90 degrees.

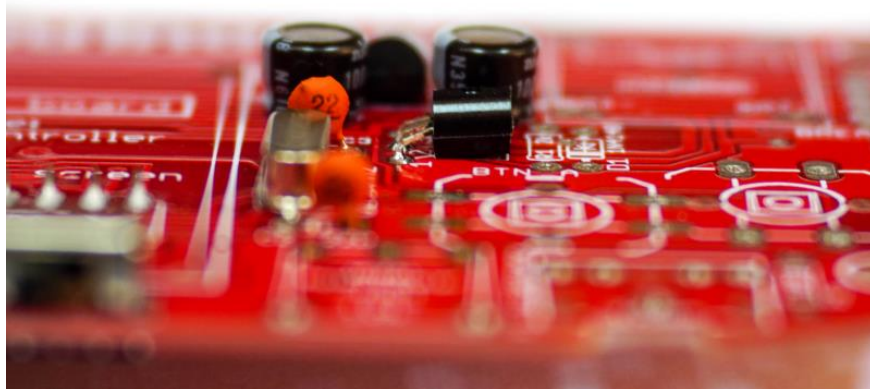

## Step 9 – Nokia 5110 LCD screen

**Important:** Firstly, check the photo next to this text and determine the version of the screen you have.

If you've got the new screen, just proceed.

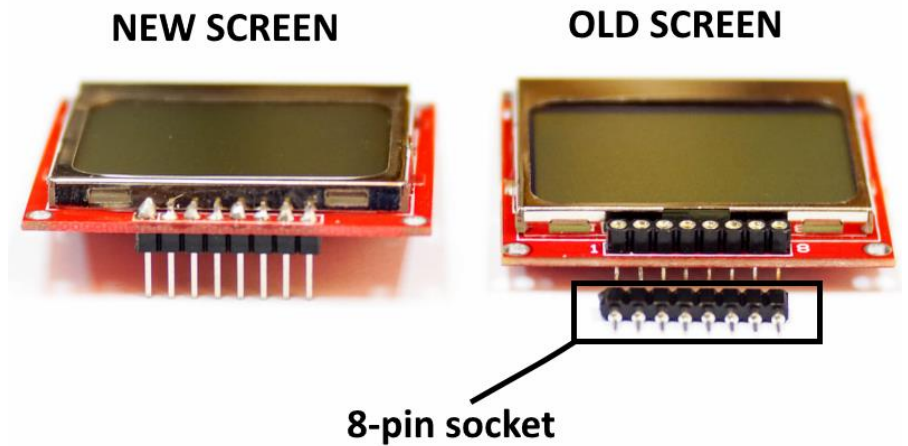

If you've got the old screen, you will have to solder the tiny female connector first and then plug the Nokia screen into the connector.

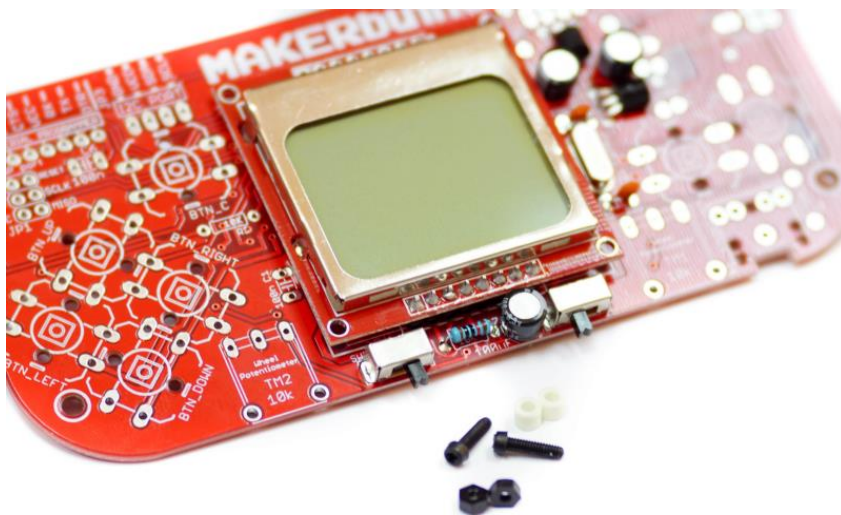
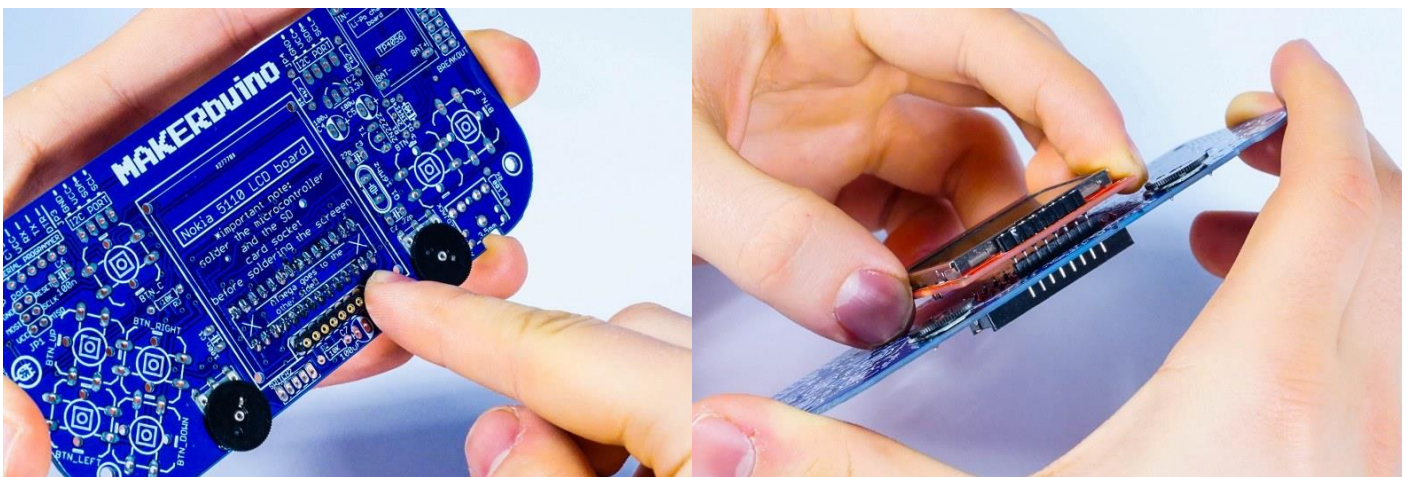

If you've got a new screen, you will just have to solder it directly to the PCB.

You'll need M2 screws, nuts, and spacers for mounting your screen.

**Important:** check whether the soldering joints on your microcomputer's socket are soldered nice and clean and that they are all shaped like a "volcano".

You have to make sure connections on the microcontroller are good because you won't be able to fix them after you solder the screen (the screen overlaps the socket's soldering joints).

**Important:** before soldering the screen to the PCB, fasten its bottom two holes with screws, nuts, and spacers. In this way, you'll ensure that the screen module is aligned perfectly before soldering it to the PCB.

You will only be able to fixate the screen using the bottom two holes on it.

After you've fixated the screen, solder the connector on the other side of the PCB and avoid bridging between pins.

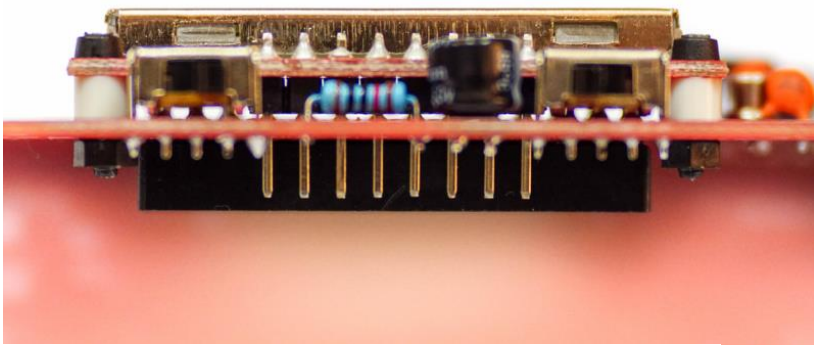

## Find the notch!

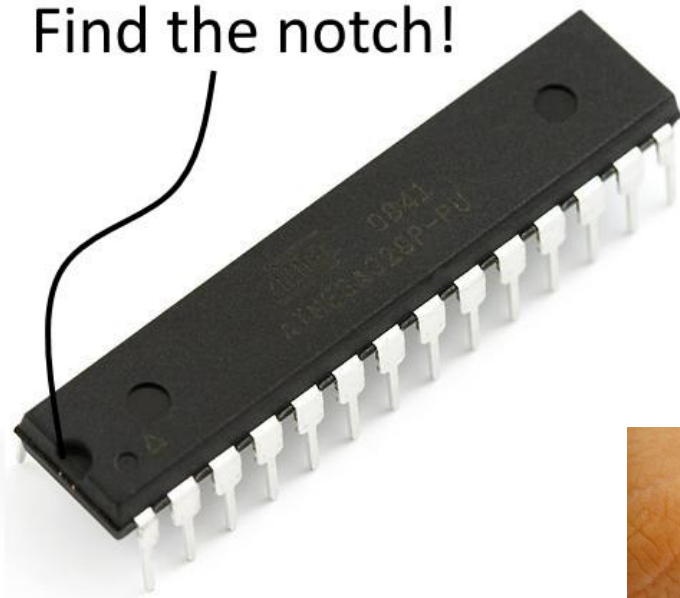

## Step 11 – Insert the ATmega328 microcomputer

Let's start by finding the little black precious microcomputer. Here comes the tricky part...

**Important:** Most common mistake that people do with the microcontroller is that they either insert it in the socket wrongly or break the microcontroller's tiny pins in the process of inserting it. Don't worry, it just needs a tiny bit of caution and concentration (don't hurry with this one).

Firstly, locate the microcontroller's notch indicating which side to turn it when inserting it in the socket.

Secondly, **DON'T insert the microcontroller straight away.** You'll need to bend the pins a bit. Do this pushing the microcontroller's pins against the table so that you apply equal force to all pins.

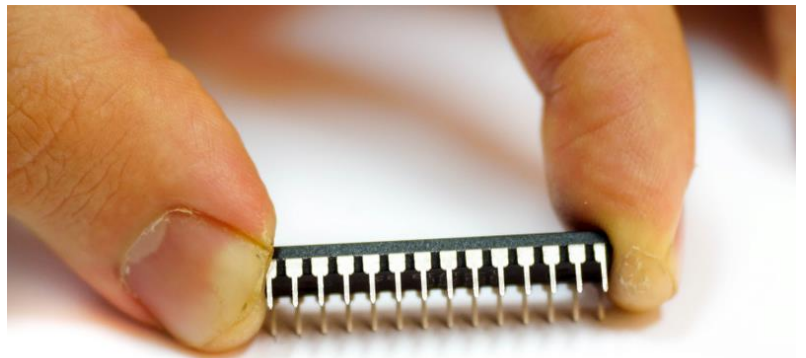

Check whether there are pins on the microcomputer that are not bent correctly and correct that.

Finally, **slowly** insert the microcontroller into the socket. **If needed, take the chip out and bend the pins some more.** A properly fully inserted chip should look like the photo next to this paragraph.

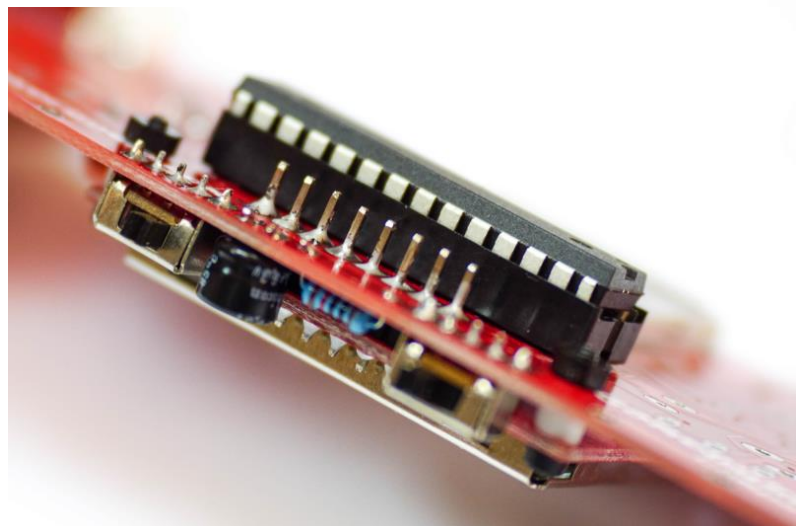

## Step 12 – first functionality test

Ok, here comes the real deal.

We've just soldered all of the core MAKERbuino components required for its basic functions and we're going to test them.

Connect the battery to the already soldered female battery connector.

Turn the device on by moving the power switch into the left position.

The screen should turn on and display some text.

If that happened, that means all of the components so far work fine and are properly soldered **feel free to proceed to the next chapter**.

Don't worry if your screen is too dim, we're going to fix that in the settings when we solder the rest of the components. It might also display the text saying "battery low, please turn off", don't worry about that – it will disappear after you finish the settings section at the end of the build process.



If the screen didn't turn on, please take a deep breath, chill, take a nap, and try the following fixes:

- Is the microcomputer inserted into the socket on the right side? (return to step 11 and mind the notch)
- Check whether you've soldered the regulator and the transistor to the right places (return to step 8)
- Are the regulator and the transistor soldered to the right side? (return to step 8)
- Check whether all of your soldering joints have a nice "volcano" shape. Fix the joints that seem suspicious by heating them with the soldering iron. Check the joints for bridged contacts and "unbridge" them (take a look at the first image of this chapter)
- Are the electrolytic capacitors turned the right way (return to step 7 and mind the polarity)
- If you've tried all of the above advice and still can't figure out what's wrong with your device, please send us a calm email with photos of your board's front and back side to [contact@makerbuino.com](mailto:contact@makerbuino.com) OR create a topic in the [support category of the MAKERbuino community forum](#) (and include the photos of the device's front and back side) OR contact us via Facebook's Messenger at [www.facebook.com/makerbuino](http://www.facebook.com/makerbuino)

## CHAPTER #4

Some more soldering... You've passed the worst part. Just a couple of components more and we're done... this will be a piece of cake

### Step 13 – solder the second 10k ohm resistor

This resistor is important for connecting the microcontroller to the serial UART programmer board. It's labeled R3 and the color code goes **brown, black, black, red, brown**.

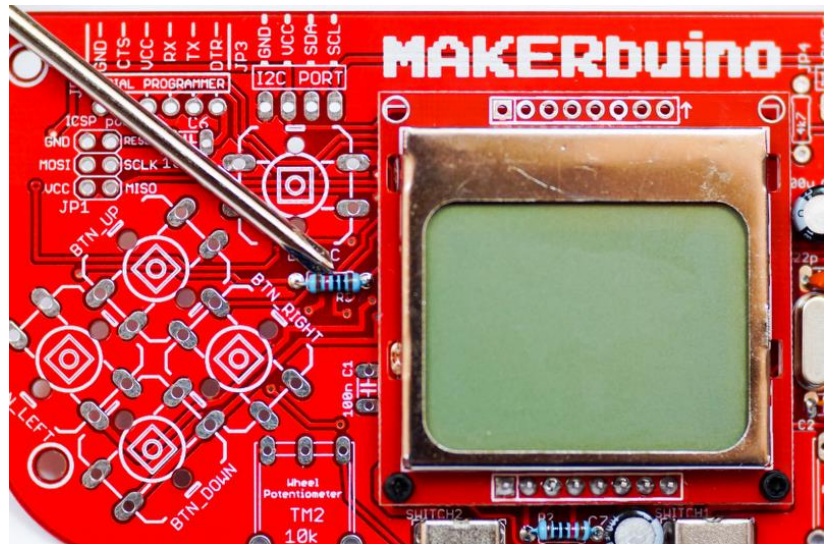

### Step 14 – female 6-pin angle header

Locate this black female connector. It's soldered to the place labeled "JP2, serial programmer". The serial UART programmer board is connected to this port. Make sure to turn it the right way.

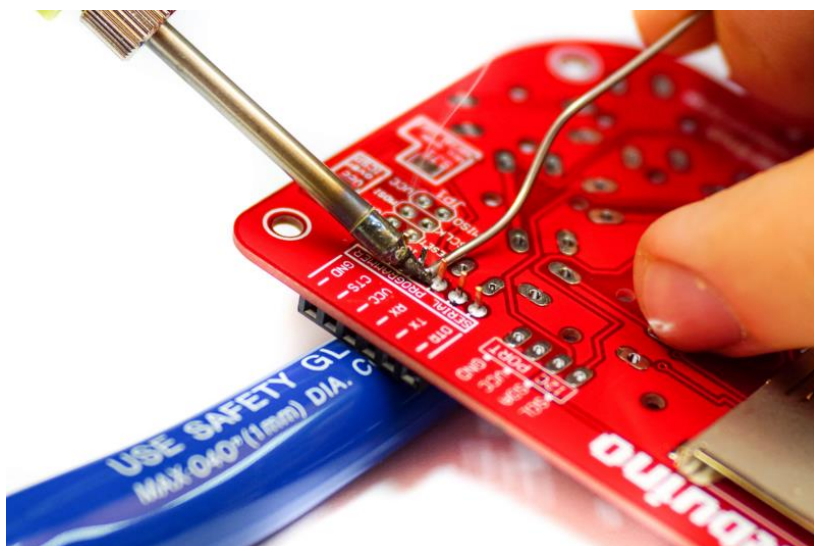
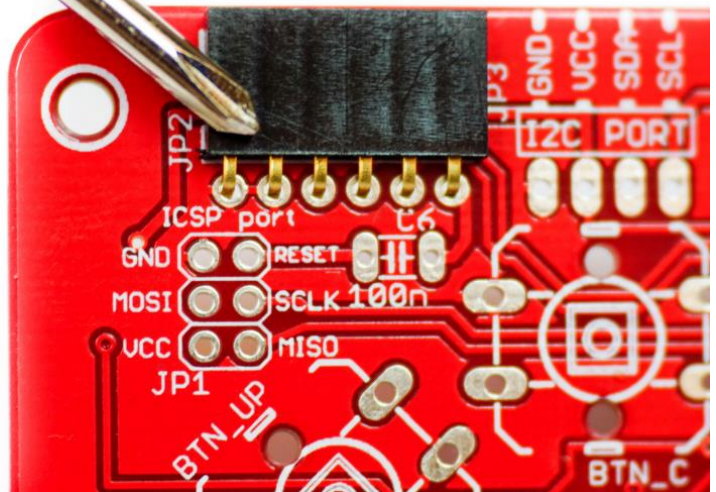

**Pro tip:** If the component is falling out of the PCB when you try to solder it, place your cutting pliers' handle underneath the component you're soldering.



## Step 15 – two wheel potentiometers

Now we'll locate and solder the two trim potentiometers labeled TR1 & TR2. The left potentiometer is used for regulating the screen's backlight and the right one regulates the sound volume.



Make sure to use our **pro tip** here and put your pliers underneath the potentiometers while soldering them.

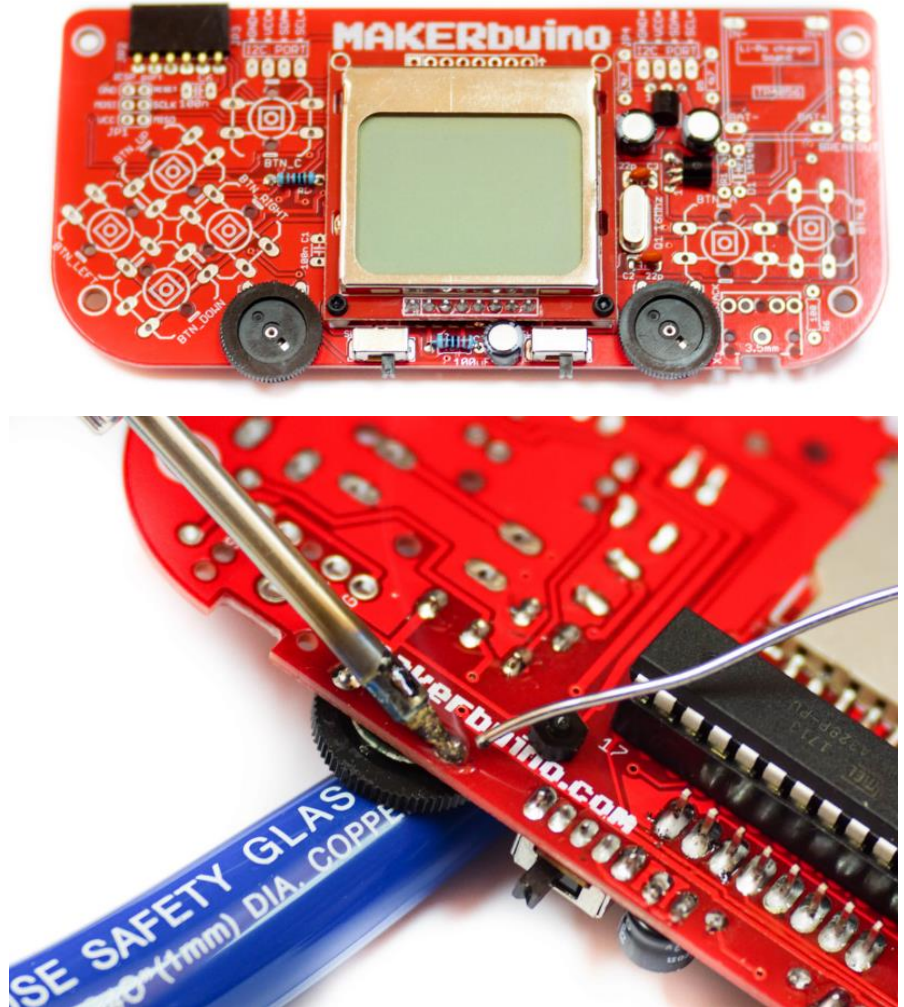

## Step 16 – 3x2 ICSP header & 100nF capacitors

The header is mounted on the top left front side of the PCB (labeled JP1). After the header, find the two little 100nF capacitors (they have 104 written on their surface) and solder them on places labeled with C1 and C6.

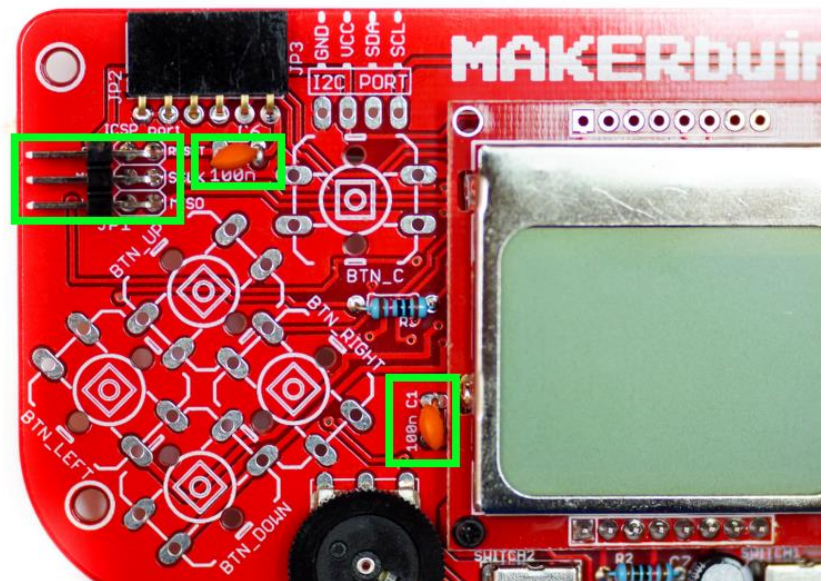

## Step 17 – some more resistors and a diode

Ok, let's solder the rest of the small two-leaded components.

- Solder the 2.2k ohm resistor (**red, red, red, golden**) to the place marked "R1, 2k"
- 100 ohm resistor (**brown, black, brown, golden** OR brown, black, black, black, brown) to the spot marked "R6, 100"
- two 4.7k ohm resistors (yellow, purple, red, golden) need to be placed on the marking "R4, 4k7" and "R5, 4k7"
- 1N4148 diode needs to go where "D1, 1N4148" is written on the board. **Important:** mind the polarity of the diode by making sure that the black ring on the diode matches the marking on the PCB

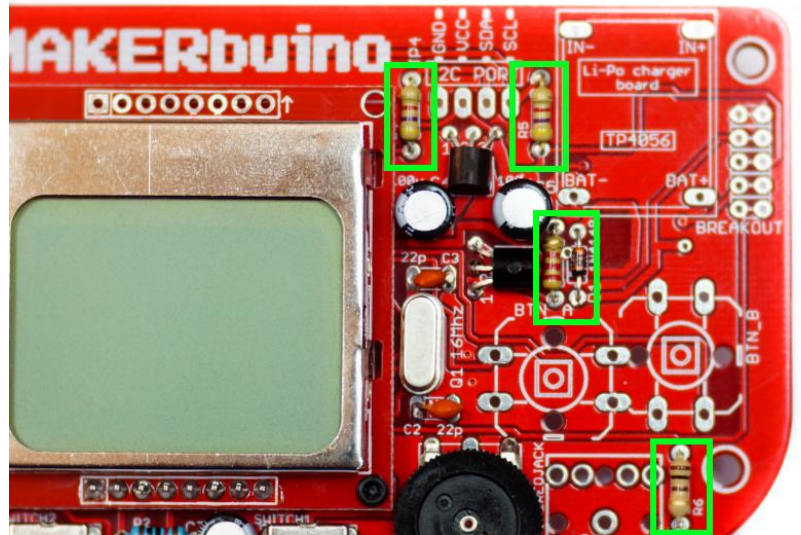

## Step 18 – headphone connector

The headphone connector goes to the place marked "X1, STEREOJACK".

Although this connector was built for stereo sound output, MAKERbuino can only output beeps and bleeps in mono.

Because of that, both left and right earphone are bridged together and connected to the same sound output channel on the microcomputer.

Make use of our previous **pro tip** and place your pliers beneath the connector so that it doesn't fall off while you're soldering it.

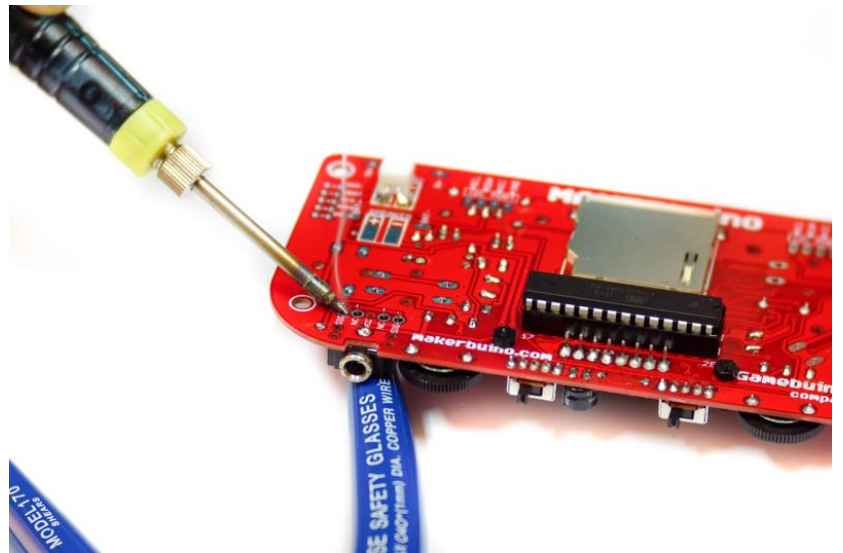

## Step 19 – Li-Po charger board

For mounting the TP4056 Li-Po charger board, you'll need to make use of those tiny excess cut-off leads we've told you to save on step 3. Pick four of the longest leads from the pile of excess leads and insert them

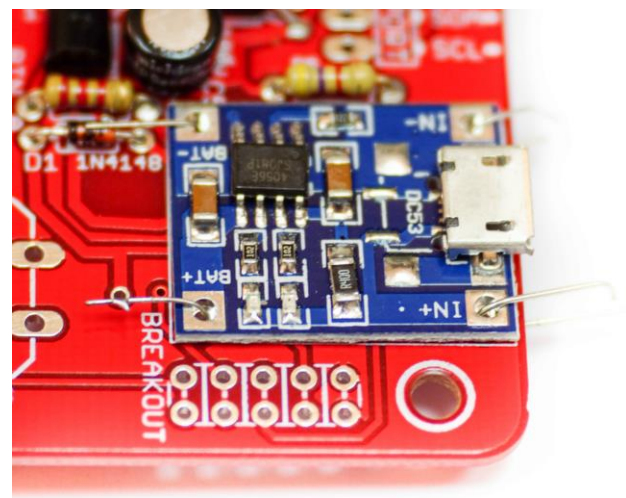
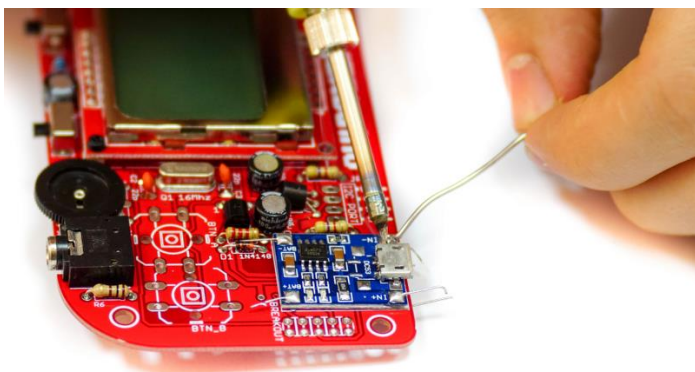

through charger's and PCB's contacts and bend them before soldering.

You need to solder the contacts both on the top and the bottom side of your MAKERbuino in order for the charger to work properly.

**Electronics 101:** This way of adding stack-on PCBs to the main PCB is called the "child board design". Boards stacked onto the main PCB are called the "child boards".

## Step 20 – male 4-pin angle multiplayer headers

These are labeled as JP3 and JP4 on the board. Use the pro tip about placing the pliers underneath the component because these might be a bit harder to solder.

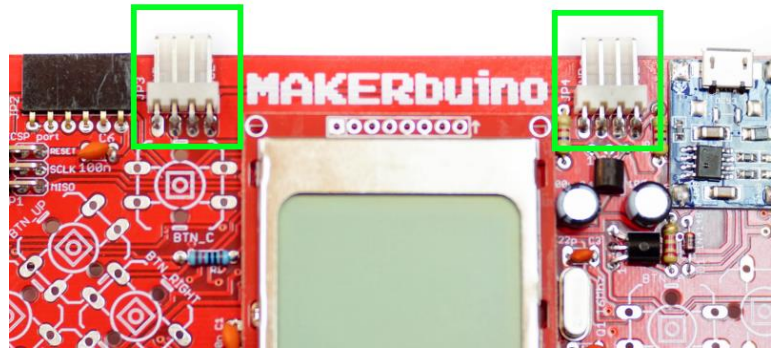

## Step 21 – seven big clicky pushbuttons

Finally! Time's to solder the yellow pushbuttons.

**Important:** make sure to push the pushbuttons all the way down to the PCB, otherwise they might get angled, which will cause them to jam when you mount the front casing.

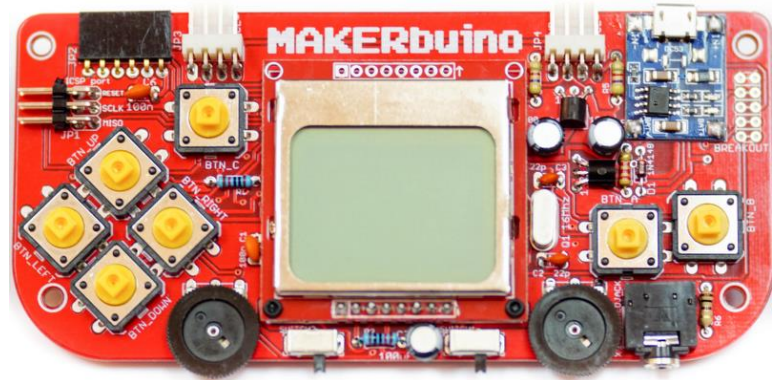

## Step 22 – connect the speaker

Let's synthesize some bleeps and bloops!  
You'll have to connect the speaker with two tiny soft wires that are included in the kit.

**Important:** When soldering the wires to the "SPEAKER" pads on the PCB, first apply some solder to the pads, and then solder the wires to the pads.

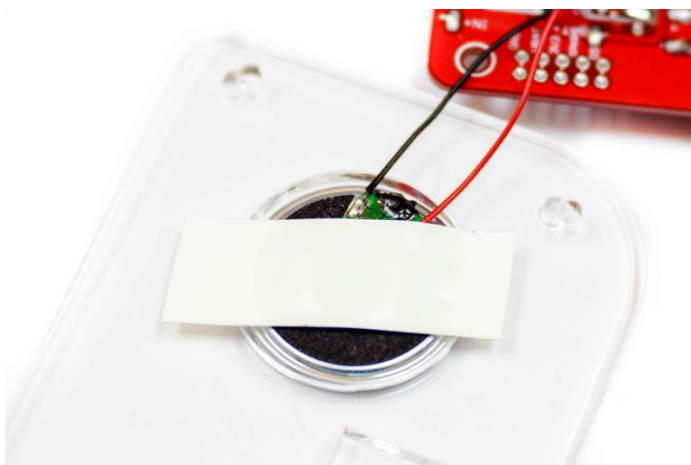
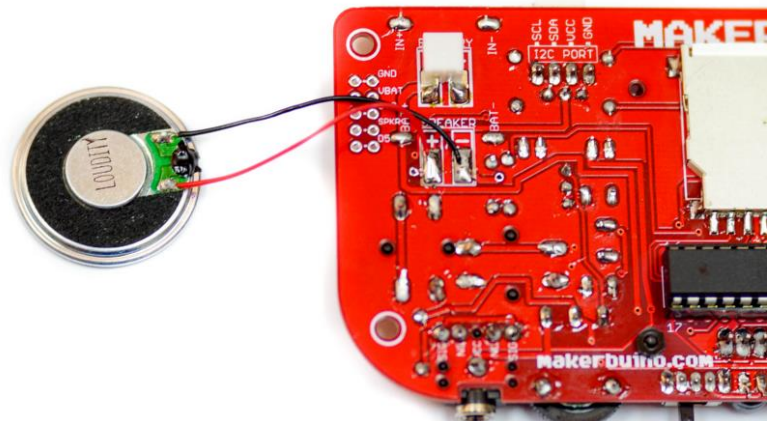

Let's fixate the speaker to the back side of the casing.  
**We recommend using a piece of insulating tape for this.**  
Alternatively, you can use a hot glue gun or some super glue.

## Extra step – the breakout header

Before turning your soldering iron off, you can solder the extra breakout header, but this is an extra and **not necessary for the normal functionality** of the MAKERbuino gaming device.

The breakout header will come in handy if you plan to **hack/mod/customize** your MAKERbuino.

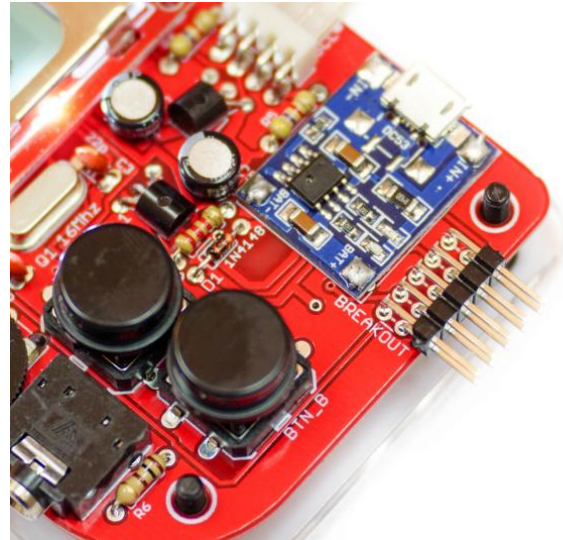

## Step 23 – test everything!

Now that you have everything soldered, connect the battery again, turn the tiny wheel potentiometers **completely to the left**(clockwise) and turn the console on.

- try dimming the screen's backlight with the left (TM2) potentiometer
- you will have an option to adjust the contrast on your MAKERbuino, this option is disabled on most new units and the LCD screens have fixed contrast which doesn't need adjusting.

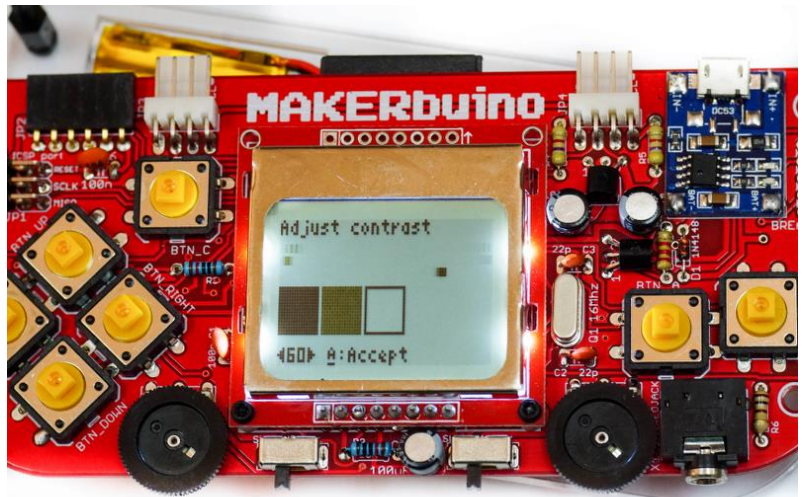

Go through the checkup wizard and check whether all buttons work properly.

After you finish the checkup wizard, the sound should be enabled. Try dimming it with the right (TM1) wheel potentiometer.

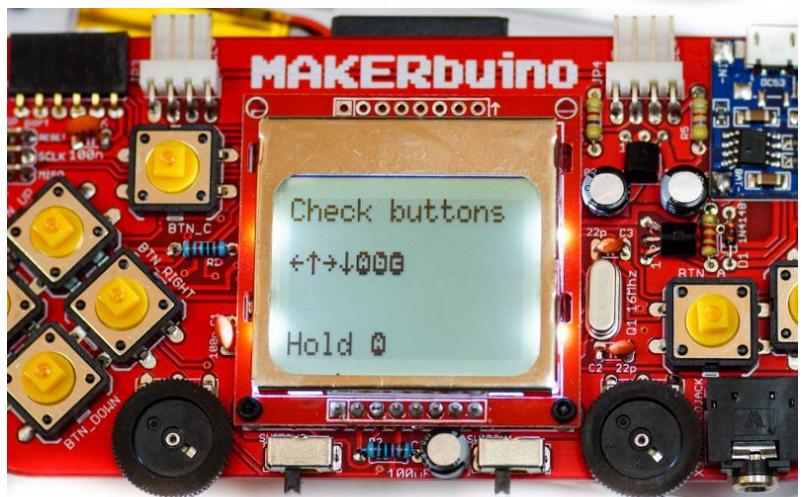

If everything's working properly, save the settings and turn the console OFF.

Insert the SD card into the socket firmly and all the way down to the bottom of the SD socket.

Turn the console ON and press button C (upmost left button) at the main screen, the device will load games and programs stored on the SD card.

You will get a loading screen.

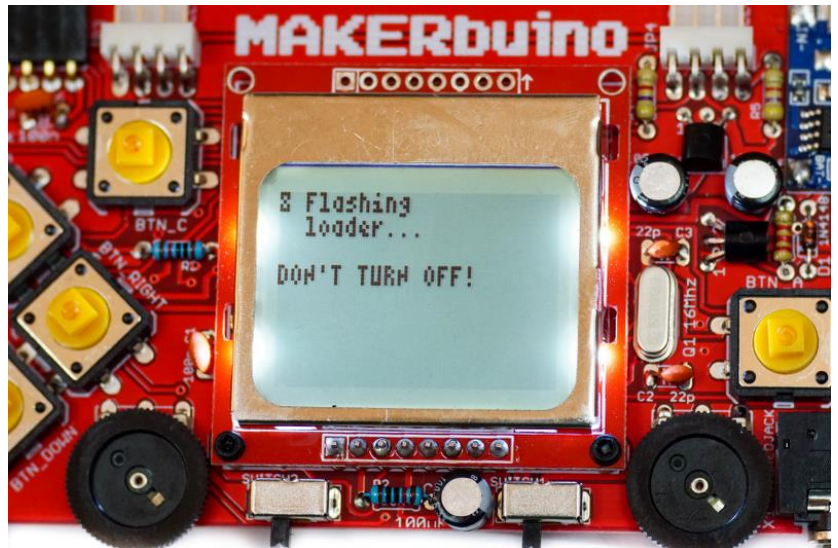

Don't panic, loading games from the SD card can take up to 30 seconds, be patient. After the SD card loads, you should see a graphical game selection screen where every image represents a separate game/program.

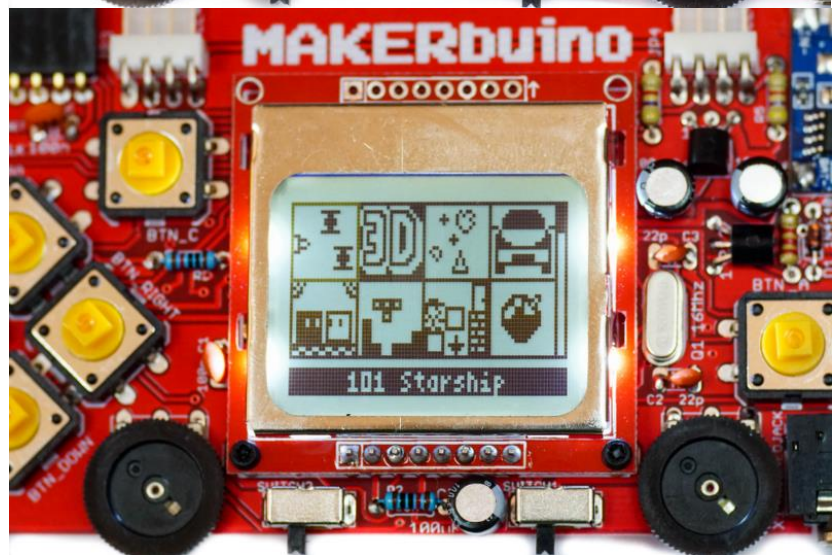

## IMPORTANT

If you turn your MAKERbuino OFF while a game is loading, its memory might be left blank and you'll get a white screen. Fortunately, this can be fixed quite easily.

You will have to do the C-button reset trick like this:

- 1) insert the SD card
- 2) turn the console OFF
- 3) hold the C button
- 4) turn the console ON
- 5) release the C button
- 6) wait for 30 seconds

The SD card loader menu should appear.

## CHAPTER #5

### Just a couple of finishing touches

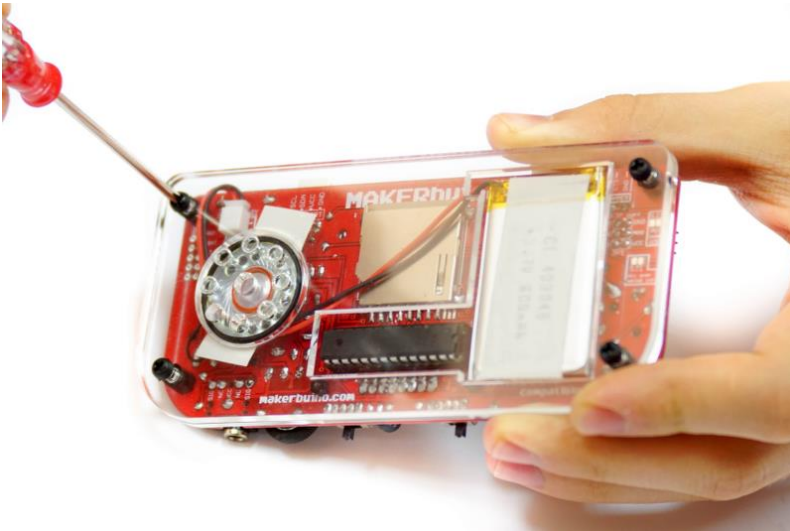

If everything electronics-related is working fine, the last step is to put the guts (electronics) in a nice crystal clear acrylic casing so that everyone can see your perfect soldering joints!

Start by assembling the bottom side of the casing, which consists of two pieces of plastic.

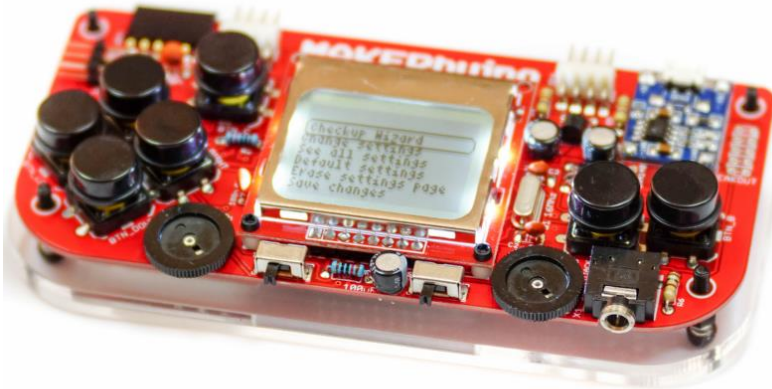

Next up, place the colored button caps to the yellow pushbuttons by simply snapping them on (you will have to apply some force and that is completely normal).

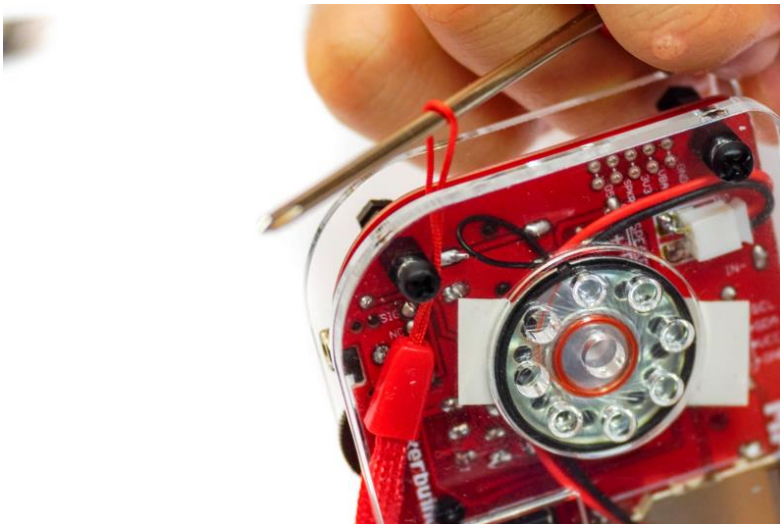

Continue by mounting the front plate and fixating it with black hexagonal M3 spacers and nuts.

Some newer versions of the kit have a hand-strap included.

If your kit has a hand-strap, you can now place it around the bottom right hexagonal M3 spacer.

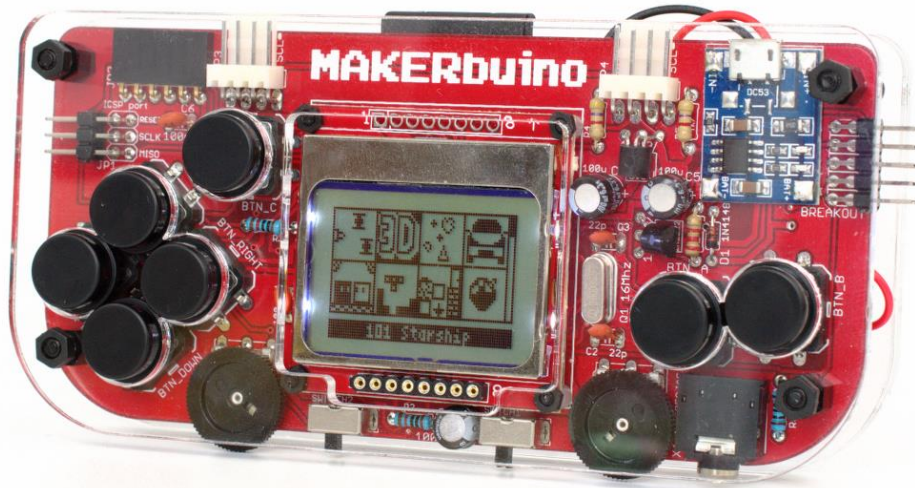

**That's all folks!**

Now look at you, you've managed to make your own working gaming device out of a bag of tiny electronic components.

Well done, you should be proud of yourself!

## CHAPTER #6

Ok you've built your MAKERbuino... now what?



### Code your very own video game!

The red UART adapter board is used for connecting your MAKERbuino to your PC so that you can upload programs on it and get some useful debug info.

You can find a beginner's coding guide here: <https://www.makerbuino.com/coding-getting-started>

### Download a game from the games gallery

Yes, there is a game gallery of compatible user-made video games here → <https://www.makerbuino.com/creations/>  
The process is simple, you'll just have to load the game's .HEX and .INF file to your SD card.



### Expand MAKERbuino's hardware

MAKERbuino can be used for interfacing with Arduino-compatible hardware components and modules just like when using an Arduino UNO board.

### Make a custom casing

Make your MAKERbuino unique with a custom casing! 3D print it, carve it out of wood or use Legos. Make sure to show us your creation on the [community forum](https://community.makerbuino.com/) → <https://community.makerbuino.com/>

