







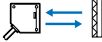

Built-in power supply photoelectric sensor

# E3JK

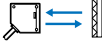
*Wide range voltage  
power supply*



Sensor type	Shape	Connection method	Sensing distance	Output form	Output	Model		
Through-beam		Pre-wired models	 5m	Light ON	Relay output	E3JK-5M1		
				Dark ON		E3JK-5M2		
				Light ON/ Dark ON (selectable)	DC transistor output	NPN: E3JK-5S3		
Retroreflective model (with M.S.R. function)			Pre-wired models	 2.5m (3m)*	Light ON	Relay output	E3JK-R2M1	
					Dark ON		E3JK-R2M2	
					Light ON/Dark ON (selectable)	DC transistor output	NPN E3JK-R2S3 PNP E3JK-R2R3	
Retroreflective model (without M.S.R. function)				Pre-wired models	 4m (5m)*	Light ON	Relay output	E3JK-R4M1
						Dark ON		E3JK-R4M2
						Light ON/Dark ON (selectable)	DC transistor output (NPN)	E3JK-R4S3
Diffuse-reflective		Pre-wired models	 300mm		Light ON	Relay output	E3JK-DS30M1	
					Dark ON		E3JK-DS30M2	
					Light ON/Dark ON (selectable)	DC transistor output (NPN)	E3JK-DS30S3	

\* The value within the parentheses indicates the sensing distance applied when the E39-R2 reflector is used.  
 Note: The UL-listed model ends with "-US". (Example: E3JK-5M1-US). Note that the DC transistor type of the E3JK is UL-unlisted.

Accessories (Order Separately)

Slits

Slit width	Sensing distance	Minimum sensing object (typical)	Model	Quantity	Remarks
Width 1 mmx20 mm	E3JK-5□□	0.7 m	1 mm dia.	E39-S39	1 pc. each for emitter and receiver (total 2 pcs.) (Seal type long slit) Can be used with the through-beam model E3JK-5□□.

Reflectors

Name	Sensing distance (typical)		Model	Quantity	Remarks
Reflectors	E3JK-R2□□	2.5 m (rated value)	E39-R1	1	Attached to the E3JK-R2□□. Attached to the E3JK-R4□□.
	E3JK-R4□□	4 m (rated value)			
	E3JK-R2□□	3 m	E39-R2		
	E3JK-R4□□	5 m			
Small reflector	E3JK-R2□□	1 m (5 mm) *	E39-R3	1	---
Tape Reflector	E3JK-R2□□	750 mm (200 mm) *	E39-RS1	1	The M.S.R. function is available.
	E3JK-R2□□	1.2 m (200 mm) *	E39-RS2		
	E3JK-R2□□	1.5 m (200 mm) *	E39-RS3		

\* Values in parentheses indicate the minimum required distance between the sensor and reflector.  
 Note: When the reflector used is other than the supplied one, set the sensing distance to about 0.7 times of the typical example as a guideline.

Mounting Brackets

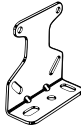
Shape	Model	Quantity	Remarks
	E39-L40	1	Supplied with E3JK

Note: If a through-beam model is used, order two Mounting Brackets for the emitter and receiver respectively.

Rating/Performance

E3JK

Sensor type		Through-beam		Retroreflective model (with M.S.R. function)		Retroreflective model (without M.S.R. function)		Diffuse-reflective	
Item	Model	E3JK-5M□	E3JK-5S3	E3JK-R2M□	E3JK-R2□3	E3JK-R4M□	E3JK-R4S3	E3JK-DS30M□	E3JK-DS30S3
Sensing distance		5 m		2.5 m (When using the E39-R1)		4 m (When using the E39-R1)		300 mm (White paper 100x100 mm)	
Standard sensing object		Opaque 14.8 dia. min.		Opaque: 75 mm dia. min.				---	
Differential distance		---						20% max. of sensing distance	
Directional angle		Both emitter and receiver: 3°C to 20°C		1° to 5°				---	
Light source (wave length)		Infrared LED (950 nm)		Red LED (660 nm)				Infrared LED (950 nm)	
Power supply voltage		12 to 240 VDC ±10% ripple (p-p) : 10% max. 24 to 240 VAC ±10% 50/60 Hz							
Current consumption	DC	3 W max.		2 W max.					
	AC	3 W max.		2 W max.					
Control output		Relay output: 250VAC 3 A (cosφ=1) max., 5 VDC 10 mA min.	DC SSR Negative common 48 VDC 100 mA max. Leak current 0.1 mA max. With load short-circuit protection	Relay output: 250VAC 3 A (cosφ=1) max., 5 VDC 10 mA min.	DC SSR Negative or positive common 48 VDC 100 mA max. Leak current 0.1 mA max. With load short-circuit protection	Relay output: 250VAC 3 A (cosφ=1) max., 5 VDC 10 mA min.	DC SSR Negative common 48 VDC 100 mA max. Leak current 0.1 mA max. With load short-circuit protection	Relay output: 250VAC 3 A (cosφ=1) max., 5 VDC 10 mA min.	DC SSR Negative common 48 VDC 100 mA max. Leak current 0.1 mA max. With load short-circuit protection
Life expectancy (relay output)	Mechanical	50 million times or more (switching frequency 18,000 times/hour)							
	Electrical	100 thousand times or more (switching frequency 18,000 times/hour)							
Response time		30 ms max.	10 ms max.	30 ms max.	5 ms max.	30 ms max.	5 ms max.	30 ms max.	5 ms max.
Sensitivity adjustment		---						Single-turn adjustment	
Ambient illuminance		Incandescent lamp: 3,000 lux max.							
Ambient temperature		Operating: -25°C to 55°C, Storage: -30°C to 70°C (with no icing or condensation)							
Ambient humidity		Operating: 45% to 85%RH, Storage: 35% to 95%RH (with no condensation)							
Insulation resistance		20 M Ω min. at 500 VDC							
Dielectric strength		1,500 VAC at 50/60 Hz for 1 minute							
Vibration resistance	De-struction	10 to 55 Hz, 1.5 mm double amplitude for 2 hours each in X, Y, and Z directions							
	Mal-function	10 to 55 Hz, 1.5 mm double amplitude for 2 hours each in X, Y, and Z directions							

Sensor type		Through-beam		Retroreflective model (with M.S.R. function)		Retroreflective model (without M.S.R. function)		Diffuse-reflective	
Item	Model	E3JK-5M□	E3JK-5S3	E3JK-R2M□	E3JK-R2□3	E3JK-R4M□	E3JK-R4S3	E3JK-DS30M□	E3JK-DS30S3
Shock resistance	De-struction	Destruction: 500 m/s <sup>2</sup> for 3 times each in X, Y, and Z directions							
	Mal-function	Destruction: 100m/s <sup>2</sup> (approx. 10G) 3 times each in X, Y, and Z directions	Destruction: 500 m/s <sup>2</sup> for 3 times each in X, Y, and Z directions	Destruction: 100m/s <sup>2</sup> (approx. 10G) 3 times each in X, Y, and Z directions	Destruction: 500 m/s <sup>2</sup> for 3 times each in X, Y and Z directions	Destruction: 100m/s <sup>2</sup> (approx. 10G) 3 times each in X, Y, and Z directions	Destruction: 500 m/s <sup>2</sup> for 3 times each in X, Y, and Z directions	Destruction: 100m/s <sup>2</sup> (approx. 10G) 3 times each in X, Y, and Z directions	Destruction: 500 m/s <sup>2</sup> for 3 times each in X, Y, and Z directions
Protective structure		IEC60529 IP64							
Connection method		Pre-wired models (standard length: 2 m)							
Weight (Packed state)		Approx. 420 g			Approx. 250 g				
Material	Case	ABS							
	Lens	Acrylics							
	Mounting bracket	Steel							
Accessories		Mounting bracket (with screws), nuts, instruction manual, reflector (retroreflective model only)							

Characteristic data (typical)

Excess Gain Ratio vs. Setting Distance

Through-beam model

E3JK-5□□

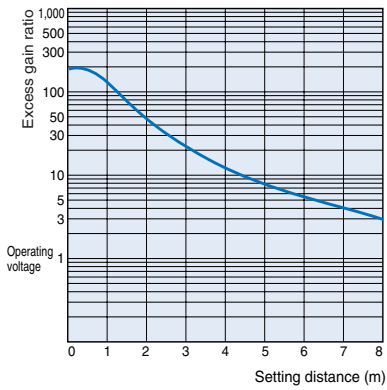

Retroreflective Models

E3JK-R2□□ + E39-R1 (supplied reflector)

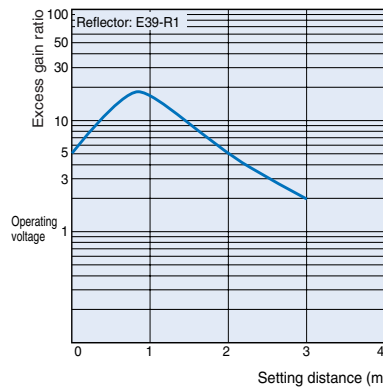

Diffuse-reflective

E3JK-DS30□□

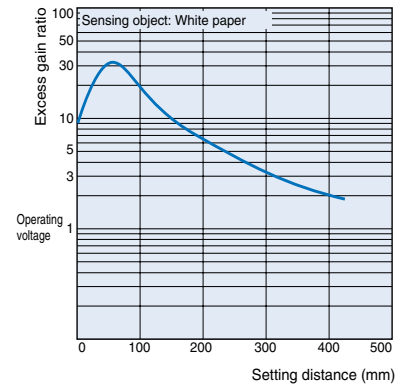

E3JK-R4□□ + E39-R1 (supplied reflector)

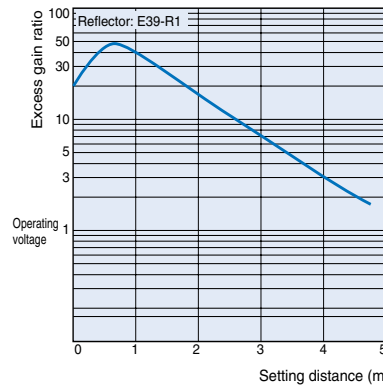

# Output Circuit Diagram

## E3JK

### Relay output

Model	Timing chart	Output circuit
E3JK-5M1 E3JK-5M2 E3JK-R2M1 E3JK-R2M2 E3JK-R4M1 E3JK-R4M2 E3JK-DS30M1 E3JK-DS30M2		<p>Built-in relay: G6C</p>

### DC transistor output



Model	Timing chart	Output circuit
E3JK-5S3 E3JK-R2S3 E3JK-R4S3 E3JK-DS30S3		
E3JK-R2R3		<p>Note: The output stage leakage currents are 0.1 mA max., respectively.</p>

Note: Connect to brown and blue on the emitter side.

E3JK

## Operation

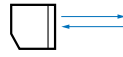
### Adjustment

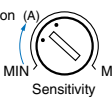
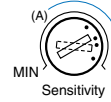
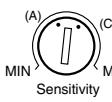
Model	Item	Through-beam	Retroreflective Models	Diffuse-reflective
E3JK		Swing the receiver and emitter vertically and/or horizontally and set the adjuster in the center of the range where the indicator of the receiver turns ON.	Like the through-beam model, adjust the reflector and emitter/receiver. Since the directional angle of the emitter/receiver is 1 to 5°, adjust the emitter/receiver especially carefully.	<div style="display: flex; justify-content: space-around;"> <div style="text-align: center;"> <p>With sensing object</p>  </div> <div style="text-align: center;"> <p>Without sensing object</p>  </div> <div style="text-align: center;"> <p>Setting</p>  </div> </div> <div style="display: flex; justify-content: space-around; margin-top: 10px;"> <div style="text-align: center;"> <p>Operation (A)</p>  </div> <div style="text-align: center;"> <p>(A) (B) Operation (C) Reset</p>  </div> <div style="text-align: center;"> <p>(A) (C)</p>  </div> </div> <ol style="list-style-type: none"> <li>(1) If you have a sensing object as shown in the figure, turn the sensitivity adjuster clockwise (increase the sensitivity) until the indicator is turned ON, and define this adjuster position as (A).</li> <li>(2) Remove the sensing object, turn the sensitivity adjuster clockwise until the indicator is turned ON by a background object, and define this position as (B).</li> <li>(3) Turn the sensitivity adjuster counterclockwise (decrease the sensitivity) from (B) until the indicator is turned OFF, and define this position as (C).</li> <li>(4) The position in the middle of (A) and (C) is the optimum position. If the indicator is not turned ON by the background object at the maximum sensitivity, set the adjuster in the middle of (A) and maximum sensitivity.</li> </ol> <ul style="list-style-type: none"> <li>• The sensitivity adjuster may be damaged if an excessive force is applied.</li> </ul>

## Precautions

### Correct Use

#### E3JK

##### Design

##### Power Reset Time

The Sensor is ready to detect an object within 200 ms after it is turned ON. If Sensor and load are connected to separate power supplies, ensure to turn ON the Sensor first.

##### Wiring Considerations

##### Connection/Wiring

If the DC transistor output type is used, the sum of load currents of L-ON output (NO) and D-ON output (NC) should be within 100 mA. If the sum of load currents exceeds 100 mA, the load short-circuit protection may be activated. (The load short-circuit protection is reset by turning OFF the power of the photoelectric sensor.)

##### Miscellaneous

##### Ambient Conditions (Installation Area)

The E3JK will malfunction if installed in the following places.

- Places where the E3JK is exposed to a dusty environment.
- Places where corrosive gases are produced.

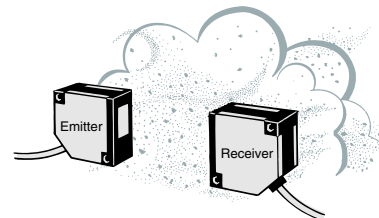

- Places where the E3JK is directly exposed to water, oil, or chemicals.

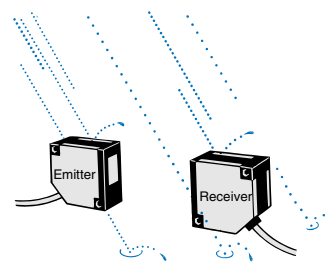

Dimensions (Unit: mm)

Sensors

E3JK-5□□

CAD file E3JK\_01

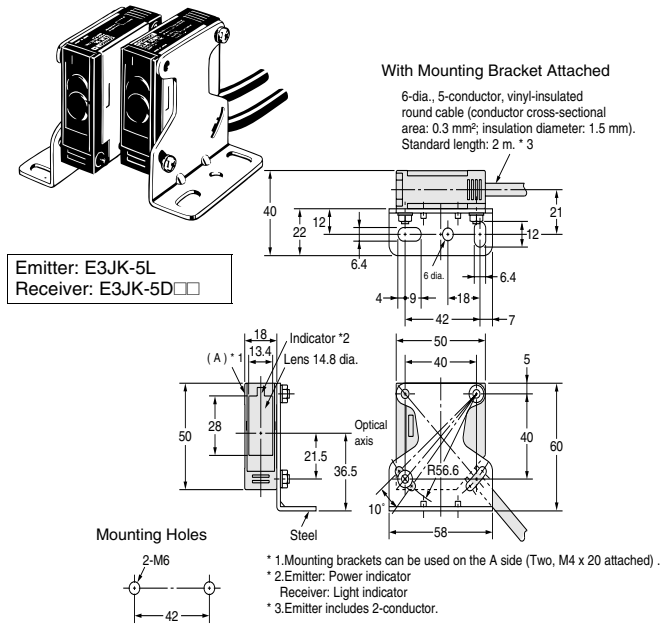

E3JK-R2□□  
 E3JK-R4□□  
 E3JK-DS30□□

CAD file E3JK\_02

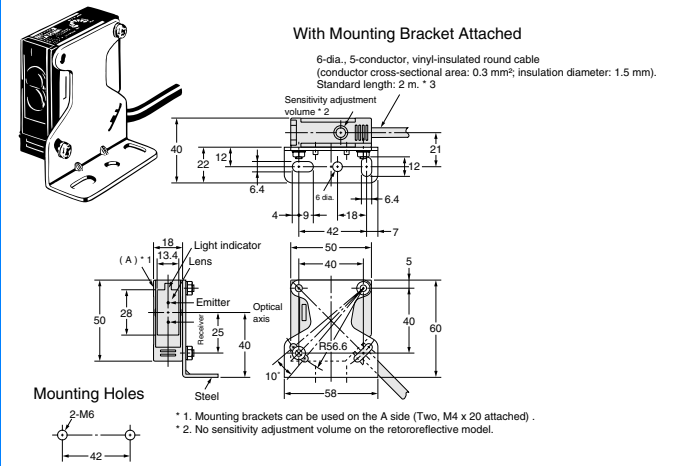

Accessories (Order Separately)

Seal type long slit (for E3JK)

E39-S39



Material: Polyester  
 0.1 mm thick

